

USER'S MANUAL



UNINTERRUPTIBLE POWER SUPPLY

SLC CUBE 3+

salicru

1. INTRODUCTION.

1.1 ACKNOWLEDGEMENT LETTER.

2. INFORMATION FOR SAFETY.

2.1. USING THIS MANUAL.

2.1.1. Conventions and used symbols.

3. STANDARD AND QUALITY GUARANTEE.

3.1. DECLARATION OF THE MANAGEMENT.

3.2. STANDARD.

3.2.1. First and second environment.

3.2.1.1. First environment.

3.2.1.2. Second environment.

3.3. ENVIRONMENT.

4. PRESENTATION.

4.1. VIEWS.

4.1.1. Views of the equipment.

4.1.2. Legend corresponding to the equipment views.

4.2. DEFINITION AND STRUCTURE.

4.2.1. Nomenclature.

4.2.2. Structural diagram.

4.3. UPS FUNCTION STAGES.

4.3.1. I/O EMI filters.

4.3.2. Rectifier-PFC stage (AC/DC).

4.3.3. Batteries.

4.3.4. Inverter stage (DC/AC).

4.3.5. Static bypass stage.

4.3.6. Maintenance or manual Bypass.

4.3.7. Terminals for EPO.

4.3.8. Control panel.

4.3.9. Control software and communications.

4.3.9.1. Control software at low level.

4.3.9.2. Managing software of the equipment.

4.3.9.3. Communications.

4.4. OPERATING PRINCIPLE OF AN EQUIPMENT.

4.4.1. Normal operating (⇔).

4.4.2. Mains fault operating (→).

4.4.3. Operating with non-active inverter (⇨).

4.4.4. Manual bypass operating (→).

4.4.5. Smart ECO Mode operating (⇨/⇔).

4.4.6. Frequency converter operating.

4.5. OPERATING STRUCTURE OF A PARALLEL SYSTEM.

5. INSTALLATION.

5.1. RECEPTION OF THE EQUIPMENT.

5.1.1. Reception, packaging and contents.

5.1.2. Storage.

5.1.3. Transport until its location.

5.1.4. Location, immobilised and considerations.

5.1.4.1. Location for single equipments.

5.1.4.2. Location for parallel systems.

5.1.4.3. Equipment immobilized and levelled.

5.1.4.4. Preliminary considerations before connecting.

5.1.4.5. Preliminary considerations before connecting, as regards to batteries and protections.

5.1.4.6. Access to inside the cabinet for its connection.

5.2. CONNECTION.

5.2.1. Connection to mains, terminals (X1 to X4).

5.2.2. Connection of separate static bypass line, terminals (X14 a X17). CUBE3+ B version only.

5.2.3. Connection to the output, terminals (X6 to X9).

5.2.4. Connection to the battery terminals of the equipment (X11, X12 and X23), with the battery modules (X47, X48 and X49).

5.2.5. Connection to the input main protecting earth terminal (X5) and the earth bonding terminal (X10) .

5.2.6. Relay COM port. Connector (X32).

5.2.7. RS232/RS485 and USB COM 0 ports.

5.2.7.1. RS232/RS485 COM 0 ports. Connector (X31).

5.2.7.2. COM or USB port. Connector (X31_{USB}).

5.2.8. EPO terminals (X50).

5.2.9. Auxiliary contact and battery temperature probe terminal strip.

5.2.9.1. Terminal strip, auxiliary contact of manual bypass switch (X51).

5.2.9.2. Terminal strip, auxiliary contact of output switch (X45).

5.2.9.3. Terminal strip, battery temperature probe (X34). For batteries in a separate cabinet only.

5.2.9.4. Ethernet connectors (X34_{ETH}) in the UPS and (X38_{ETH}) in the battery cabinet. For separate battery cabinets and probe bundle > 5 m, only.

5.2.10. Connection of parallel BUS (X36i) and (X36o).

5.2.10.1. Connection of the communication or BUS bundle (BC).

6. OPERATING.

6.1. RELEVANT PRELIMINARY CONSIDERATIONS .

6.2. UPS OR SYSTEM START UP.

6.2.1. Controls before starting up.

6.2.2. Start up procedure.

6.2.2.1. First start up procedure.

6.2.2.2. Daily start up procedure, for equipments with alphanumerical display.

6.2.2.3. Daily start up procedure, for equipments with touchscreen.

6.2.2.4. Considerations regarding Master and Slave (parallel systems only).

6.3. SHUTDOWN OF AN EQUIPMENT FROM PARALLEL SYSTEM.

6.4. TO START UP THE UPS OF PREVIOUS SECTION.

6.5. COMPLETE SHUTDOWN OF THE UPS OR SYSTEM.

6.6. EMERGENCY POWER OFF (EPO) BUTTON OPERATION.

6.7. SMART ECO MODE OPERATING.

6.8. MANUAL BYPASS SWITCH (MAINTENANCE).

6.8.1. Operating principle.

6.8.2. Transference to maintenance bypass.

6.8.3. Transference to normal operating, equipments with alphanumerical panel.

6.8.4. Transference to normal operating, for equipments with touch screen.

7. DESCRIPTION OF THE CONTROL PANEL.

7.1. CONTROL PANEL PARTS.

7.2. BASIC FUNCTIONS OF THE SYNOPTIC KEYPAD.

7.2.1. Messages menus and classification of the submenus.

7.3. SCREEN DESCRIPTION.

7.3.1. Main level (screen menu 0.0). See Fig 44.

7.3.2. "CONTROL AND STATUS OF THE EQUIPMENT" level See Fig 45.

7.3.3. "MEASUREMENT" level (screen menu 2.0). See fig. 46.

- 7.3.4. "PARAMETERS" level (screen menu 3.0). See fig 47.
- 7.3.5. "ALARMS" level (menu screen 4.0). See Fig 48.
- 7.3.6. "DATA LOGGER" level (menu screen 5.0). See Fig 49.
- 7.3.7. "CONFIGURATION" level (menu screen 6.0). See Fig 51.
- 7.3.8. Nominal values screens (menu screen 7.0). See Fig 50.

8. MAINTENANCE, WARRANTY AND SERVICE.

- 8.1. MAINTENANCE BASIC GUIDE.
 - 8.1.1. Battery fuses.
 - 8.1.2. Batteries.
 - 8.1.3. Fans.
 - 8.1.4. Capacitors.
- 8.2. WARRANTY CONDITIONS.
 - 8.2.1. Warranty terms.
 - 8.2.2. Out of scope of supply.
- 8.3. TECHNICAL SERVICE NETWORK.

9. ANNEXES.

- 9.1. PARTICULAR SPECIFICATIONS, EQUIPMENTS (LV).
- 9.2. TECHNICAL SPECIFICATIONS, EQUIPMENTS (HV).
- 9.3. GLOSSARY.

1. INTRODUCTION.

1.1 ACKNOWLEDGEMENT LETTER.

We would like to thank you in advance for the trust you have placed in us by purchasing this product. Read this instruction manual carefully in order to be familiar with its contents, because as much you understand and know the equipment, the higher will be the satisfaction degree, safety level and functionality optimization.

We remain at your entire disposal for any further information or any query you should wish to make.

Yours sincerely.

SALICRU

- The equipment here described **can cause important physical damages due to wrong handling**. This is why, the installation, maintenance and/or fixing of the here described equipment must be done by our staff or **specifically authorised**.
- Although no effort has been spared to guarantee that the information in this manual is complete and accurate, we are not responsible of any errors or omissions that may exist.
The images included in this document are for mere illustration and may not accurately represent the parts of the equipment showed. However, the differences that may arise will be smoothed or solved with the correct labelling on the unit.
- According to our policy of constant evolution, **we reserve the right to modify the specifications, operating or described actions in this document without forewarning**.
- All **reproduction, copy, third party concession, modification or part or total translation** of this manual or document, in any form or medium, **without the previous written authorization** of our firm, it is prohibited, reserving of the complete and exclusive property right over itself.

2. INFORMATION FOR SAFETY.

2.1. USING THIS MANUAL.

- The purpose of the SLC.CUBE3+ documentation is to provide information regarding safety and to give explanations about the procedures for the installation and operating of the equipment. The generic documentation of the equipment is supplied in digital format in a Compact Disc (Pendrive) and it includes among other documents the own user's manual of the system.
- Together with this user's manual and included in the documentation CD/Pendrive, it is supplied the EK266*08 document regarding to **«Safety instructions»**.

Read this manual carefully before making the erection or commissioning, location change, setting or any kind of handling in the equipment.



Compliance as regards to «Safety instructions» is mandatory, being the user the legal responsible

regarding to its observance and application. Read them carefully and follow the stated steps in the established order.

- The equipments are supplied duly labelled for the correct identification of each part, which together with the instructions described in this user's manual allows making any operating of the erection and commissioning, in an easy, ordered way, without doubt.

Finally, once the equipment is installed and working, it is recommended to keep the documentation CD/Pendrive in a safe place and with easy access, for future consults or doubts that could arise.

- When an equipment differs from the figures shown in section 4, there will be additional explanatory annexes if they were needed. In general they will be given in hardcopy.
- The following terms are used in the document to be referred to:

«SLC.CUBE3+, CUBE3+, equipment or unit».- Uninterruptible Power Supply.

Depending on the context of the sentence, it can be referred either to the own equipment or to the equipment with batteries, although all is assembled in one cabinet or metallic enclosure.

«Batteries or accumulators».- Group or set of elements that store the electron flow through electrochemical means.

«T.S.S.».- Technical Service & Support.

«Client, installer, operator or user».- Both are used, but it also includes the terms of fitter and/or operator, who will make the corresponding actions, being able to fall over this person the responsibility of making the respective actions to act in the name or behalf of the user.

- In case of installing the equipment in IT neutral regime, the switches and circuit breaker protections must break the NEUTRAL as well as the three phases .
- Inside the battery cabinet there are accessible parts with HAZARDOUS VOLTAGES, so electrical shock risk exists, therefore it is classified as RESTRICTED ACCESS AREA. This is why the key of the battery cabinet will not be available to the OPERATOR or END USER, unless he has been trained properly.

2.1.1. Conventions and used symbols.

Some symbols can be used and shown in the equipment, batteries and/or in the context of the user's manual.

For more information, see section 1.1.1 from EK266*08 document regarding to **«Safety instructions»**.

3. STANDARD AND QUALITY GUARANTEE.

3.1. DECLARATION OF THE MANAGEMENT.

Our target is the client's satisfaction, therefore this Management has decided to establish a Quality and Environmental policy, by means of installation a Quality and Environmental Management System that becomes us capable to comply the requirements demanded by the standard **ISO 9001** and **ISO 14001** and by our Clients and concerned Parts too.

Likewise, the enterprise Management is committed with the development and improvement of the Quality and Environmental Management System, through:

- The communication to all the company about the importance of satisfaction both in the client's requirements and in the legal and regulations.
- The Quality and Environmental Policy diffusion and the fixation of the Quality and Environment targets.
- To carry out revisions by the Management.
- To provide the needed resources.

3.2. STANDARD.

The **SLC CUBE3+** product is designed, manufactured and commercialized in accordance with the standard **EN ISO 9001** of Quality Management Systems. The **CE** marking shows the conformity to the EEC Directive by means of the application of the following standards:

- **2014/35/EU**. - Low Voltage Directive (LVD).
- **2014/30/EU**. - Electromagnetic Compatibility (EMC).
- **2011/65/EU**. - Restriction of Hazardous Substances in electrical and electronic equipment (RoHS).

According with the harmonised norms and certified by an external laboratory. The reference norms are:

- **EN-IEC 62040-1**. Uninterruptible power supply (UPS). Part 1-1: General and safety requirements for UPS's used in accessible areas by end-users.
- **EN-IEC 62040-2**. Uninterruptible power supply (UPS). Part 2: EMC requirements.



The manufacturers responsibility is excluded in the event of any modification or intervention in the product by the customer's side.



WARNING! This is a category C3 UPS product. This is a product for commercial and industrial application in the second environment - installation restrictions or additional measures may be needed to prevent disturbances.

Pay attention to those systems used in vital signs maintenance, medical applications, commercial transport, nuclear power stations, as well as other applications or loads where a failure in the product can cause serious personal injuries or material damages.



Declaration of conformity CE of the product is at the client disposal under previous request to our headquarters offices.

3.2.1. First and second environment.

The following examples of environment cover the majority of UPS installations.

3.2.1.1. First environment.

Environment that includes residential, commercial and light industrial premises directly connected without intermediate transformers to a public low-voltage mains supply.

3.2.1.2. Second environment.

Environment that includes all commercial, light industry and industrial establishments other than those directly connected to a low-voltage mains that supplies buildings used for residential purposes.

3.3. ENVIRONMENT.

This product has been designed to respect the environment and has been manufactured in accordance with the standard **ISO 14001**.

Equipment recycling at the end of its useful life:

Our company commits to use the services of authorised societies and according to the regulations, in order to treat the recovered product at the end of its useful life (contact your distributor).

Packaging:

To recycle the packaging, follow the legal regulations in force, depending on the particular standard of the country where the equipment is installed.

Batteries:

The batteries mean a serious danger for health and environment. The disposal of them must be done in accordance with the regulations in force.

4. PRESENTATION.

4.1. VIEWS.

4.1.1. Views of the equipment.

Figures from 1 to 20 show the illustrations of the equipments according to model, nominal operating voltage and input-output setting, which is summarised in the chart 1.

Format of protections and size of the terminals shown in the figures of this document, always correspond to the highest power rate model manufactured in that cabinet, at the same power supply voltage and input-output setting.

Nevertheless and as the product is in constant evolution, some discrepancies or small contradictions can arise. So, if any questions, the labels over the own equipment will prevail.



Each equipment model corresponds to one power rate, voltage, frequency and input and output currents. All values of these features can be checked in the nameplate, located at the back of the front door (PF), and act in your installation accordingly.

In the description of this manual, there are references to «LV» (Low voltage) and «HV» (High voltage) abbreviations, described in the nomenclature of the model with an «A» for «LV» and omitted for «HV», grouping the following interval of voltages:

- LV.- 3x200 to 3x230 V (115 to 133 V in single phase).
- HV.- 3x380 to 3x415 V (220 to 240 V in single phase).

These abbreviations do not have any other purpose than matching and/or helping in order to give a better comprehension of the detailed information in this document and even they are not shown either in the nomenclature, or in the reference of the nameplate model.

All models can operate as single units or connected in parallel with other equipments of the same family, because the needed electronic kit is already included.

Parallel connection can be done at any time when the upgrading requirements are needed to increase the supplied power of the equipment or in order to have redundant operating systems for installations with higher safety.

Do not connect **SLC CUBE3+** equipments of different features versions, settings, back up times or duplicated addresses (i.e.: two equipments, although they are identical, coming from two parallel systems and with the same address) in parallel.

In any parallel system only one and different address is assigned to each equipment that makes the system.

Model	Input - output setting	Voltage (V)	Power (kVA / kW)		Fig. nr. Front UPS cabinet		Fig. nr. Front battery cabinet			
			Setting III/III	Setting L / M / N	Door closed	Door opened	Door closed	Door opened		
SLC-5-CUBE3+	No ref. : III / III L : I / I M : I / III N : III / I	«LV» 3x200.. 3x230 V (115.. 133 V in single phase)	5 / 4.5	5 / 4	1	6 / 7 / 8 / 9	Battery cabinet for extended back up time models only, ver 15	Battery cabinet for extended back up time models only, ver 16		
SLC-7,5-CUBE3+			7.5 / 6.75	7.5 / 6						
SLC-10-CUBE3+			10 / 9	10 / 8						
SLC-15-CUBE3+			15 / 13.5	15 / 12						
SLC-20-CUBE3+			20 / 18	20 / 16						
SLC-30-CUBE3+			30 / 27	30 / 24						
SLC-40-CUBE3+	Available at setting III / III only	«LV» 3x200.. 3x230 V (115.. 133 V in single phase)	40 / 36	40 / 32	2	10	15	16		
SLC-50-CUBE3+			50 / 45	50 / 40	2	11				
SLC-60-CUBE3+			60 / 54	60 / 48	⁽⁰⁾ 3 for (-B)	⁽⁰⁾ 12 for (-B)			17	18
SLC-80-CUBE3+			80 / 72	80 / 64	4	13			19	20
SLC-100-CUBE3+			100 / 90	100 / 80	⁽⁰⁾ 5 for (-B)	⁽⁰⁾ 14 for (-B)				
SLC-7,5-CUBE3+			No ref. : III / III L : I / I M : I / III N : III / I	«HV» 3x380.. 3x415 V (220.. 240 V in single phase)	7.5 / 6.75	7.5 / 6			1	6 / 7 / 8 / 9
SLC-10-CUBE3+	10 / 9	10 / 8								
SLC-15-CUBE3+	15 / 13.5	15 / 12								
SLC-20-CUBE3+	20 / 18	20 / 16								
SLC-30-CUBE3+	30 / 27	30 / 24								
SLC-40-CUBE3+	40 / 36	40 / 32								
SLC-50-CUBE3+	Available at setting III / III only	«HV» 3x380.. 3x415 V (220.. 240 V in single phase)	50 / 45	50 / 40	2	10	15	16		
SLC-60-CUBE3+			60 / 54	60 / 48	2	11				
SLC-80-CUBE3+			80 / 72	80 / 64	⁽⁰⁾ 3 for (-B)	⁽⁰⁾ 12 for (-B)			17	18
SLC-100-CUBE3+			100 / 90	100 / 80	4	13			19	20
SLC-120-CUBE3+			120 / 108	120 / 96	⁽⁰⁾ 5 for (-B)	⁽⁰⁾ 14 for (-B)				
SLC-160-CUBE3+			160 / 144	160 / 128						
SLC-200-CUBE3+	200 / 180	200 / 160								



⁽⁰⁾ The equipments with separate static Bypass line (-B), are supplied in the same cabinet as basic models, less those ones stated in this chart with other Nr of Fig.

Table 1. Reference relation among models and illustration.

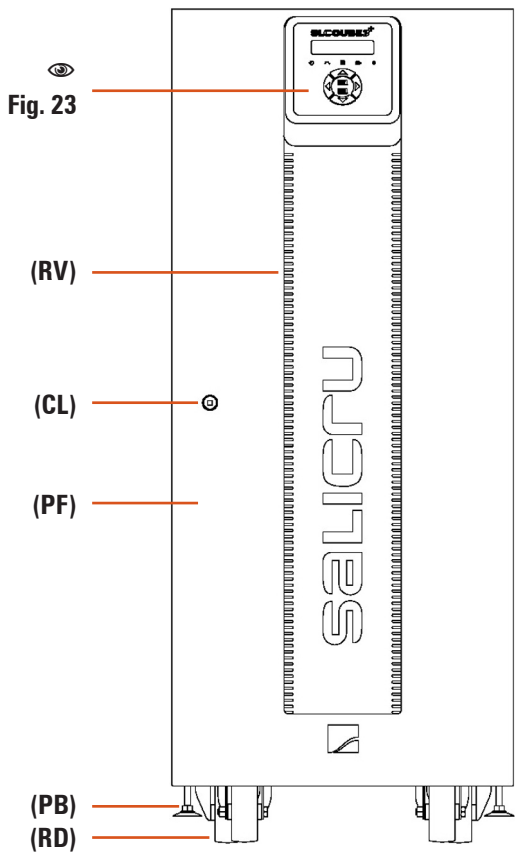

Fig. 1. UPS front view from 5 to 30 kVA (LV) / 7.5 to 60 kVA (HV), with or without separate static bypass line (-B).

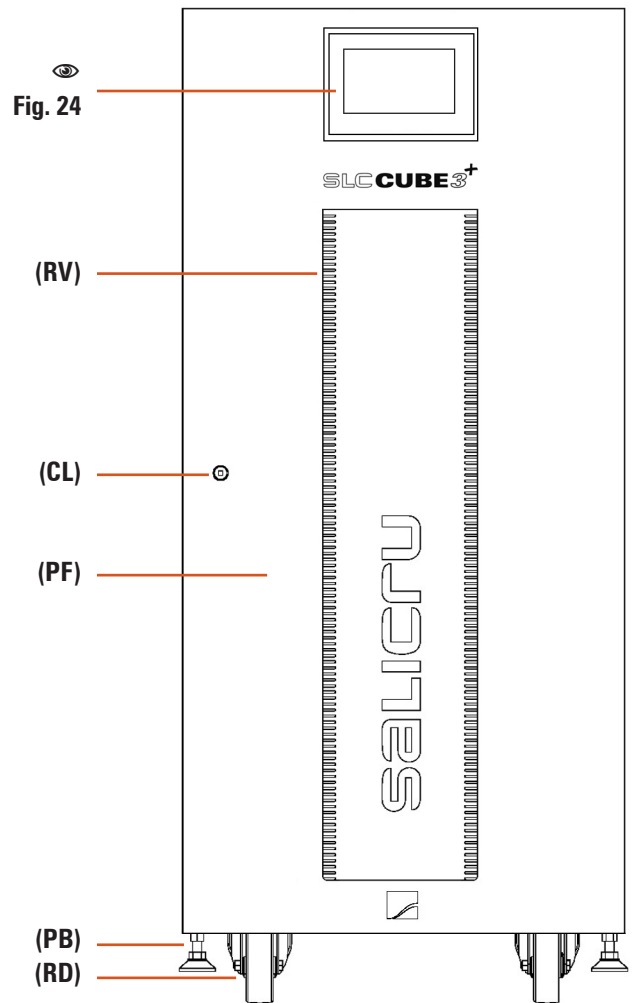

Fig. 2. UPS front view from 40 to 60 kVA (LV) / 80 to 120 kVA (HV), without separate static bypass and 40 kVA (LV) / 80 kVA (HV) with separate static bypass (-B).

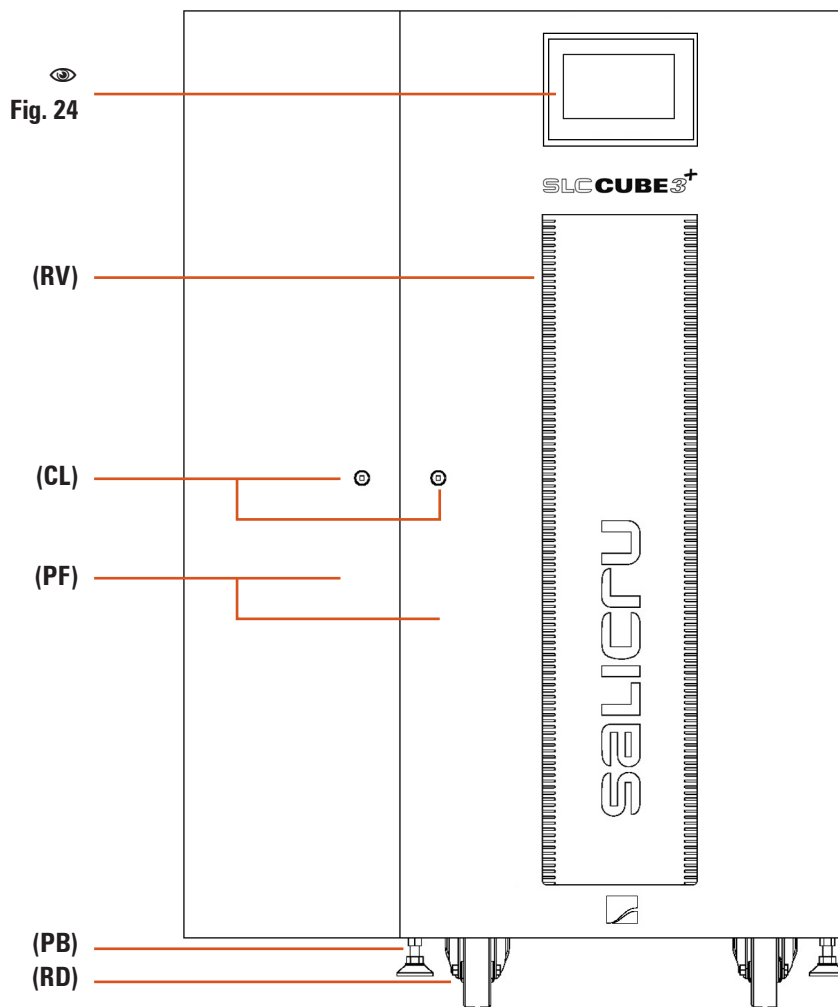

Fig. 3. UPS front view of 50 and 60 kVA (LV) / 100 and 120 kVA (HV), with separate static bypass line (-B).

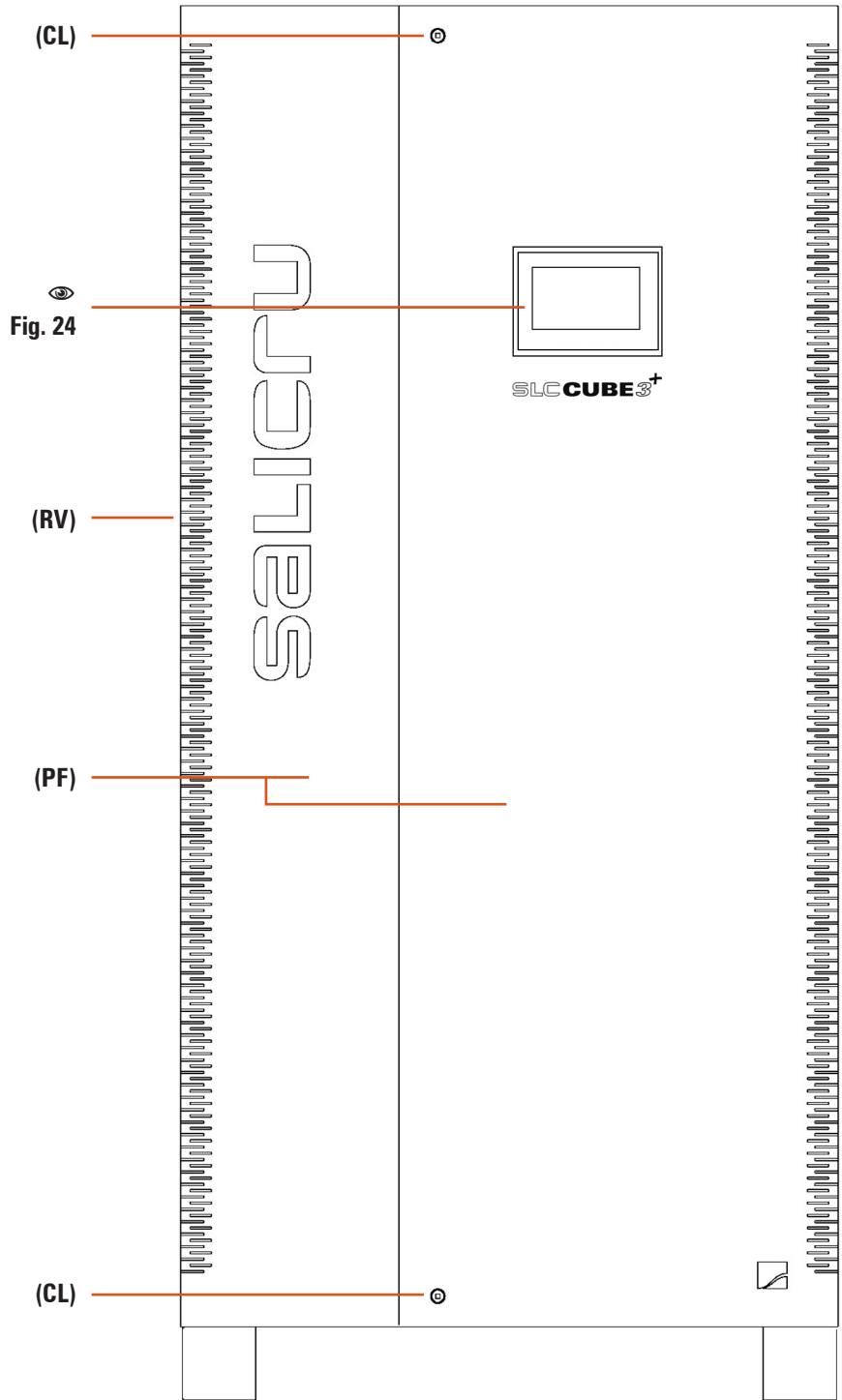
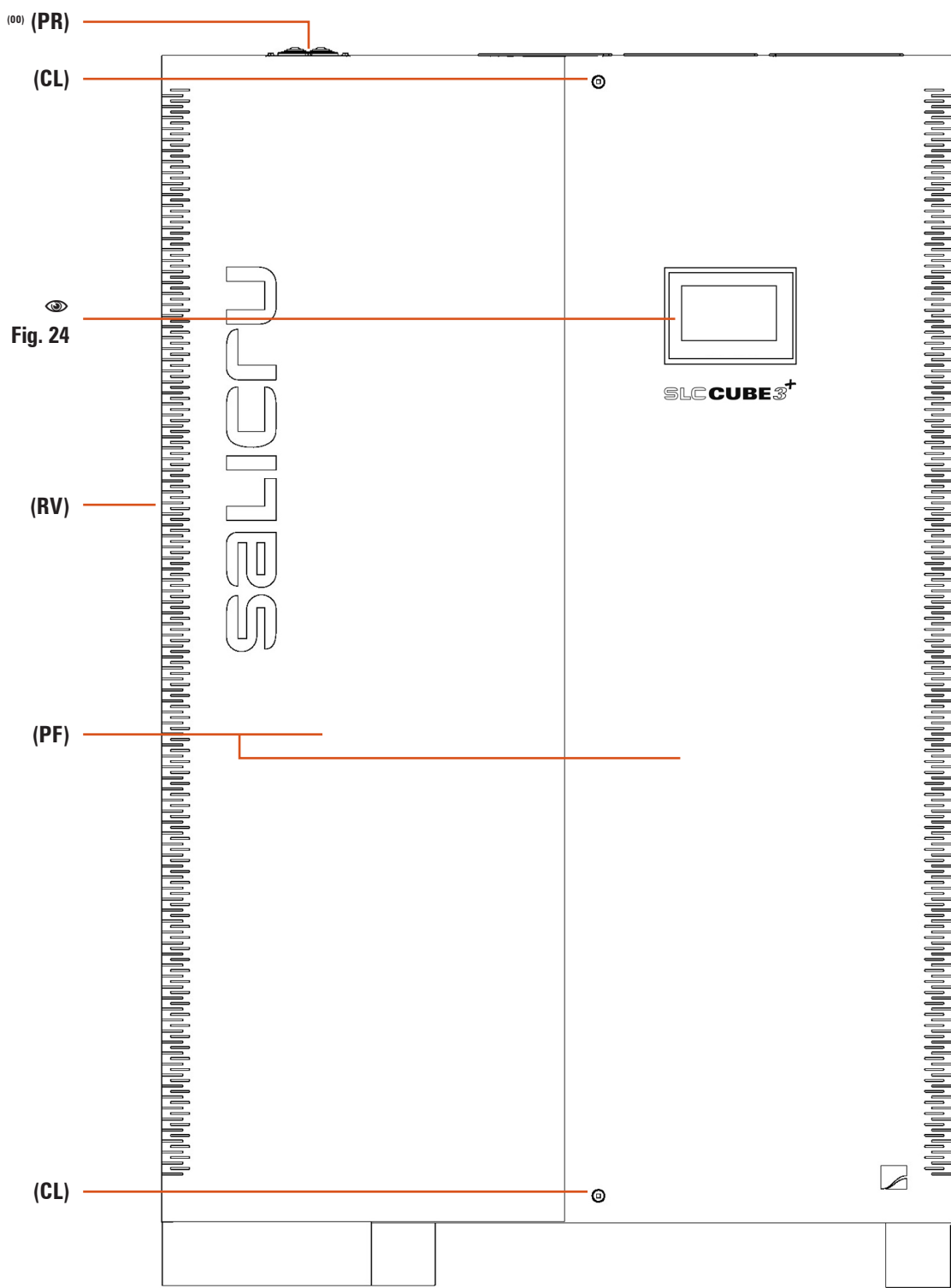
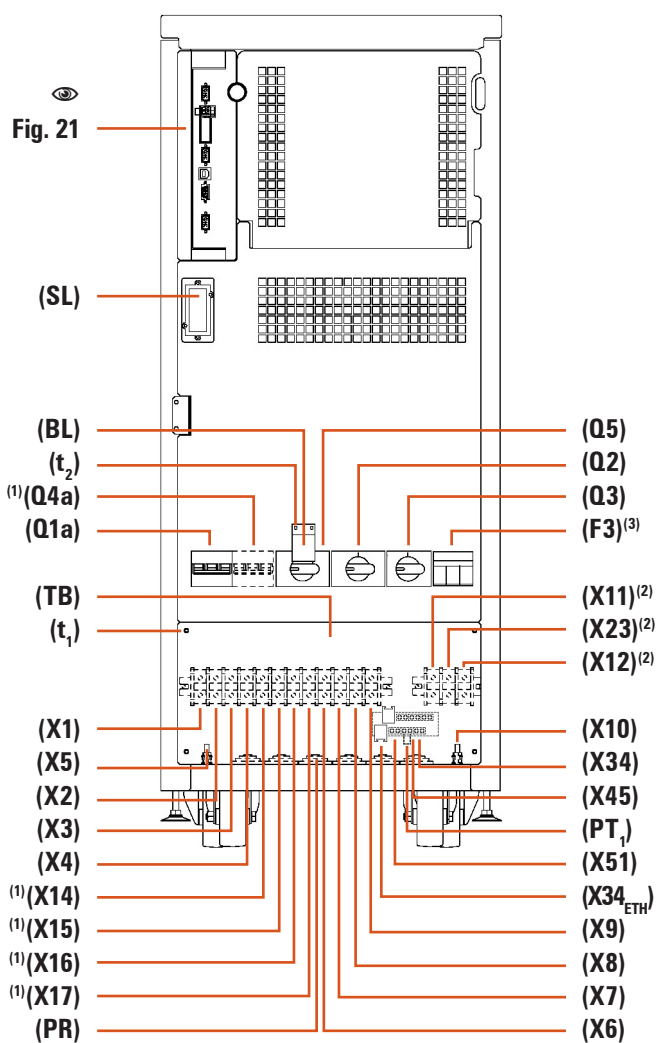

Fig. 4. UPS front view of 80 and 100 kVA (LV) / 160 and 200 kVA (HV), without separate static bypass line.



⁽⁰⁰⁾ Top entry cable (Optional).

Fig. 5. UPS front view of 80 and 100 kVA (LV) / 160 and 200 kVA (HV), with separate static bypass line (-B).



- (1) Equipments with separate static bypass line only (-B).
- (2) Equipments with extended back up time or 30 kVA (LV) / 60 kVA (HV) power rates only.
- (3) Battery protection in equipments with extended back up time only, where batteries are fitted in or ready to be fitted in part inside the own UPS cabinet.

Fig. 6. UPS front view with door opened, 5 to 30 kVA (LV) / 7.5 to 60 kVA (HV) models and III / III setting.

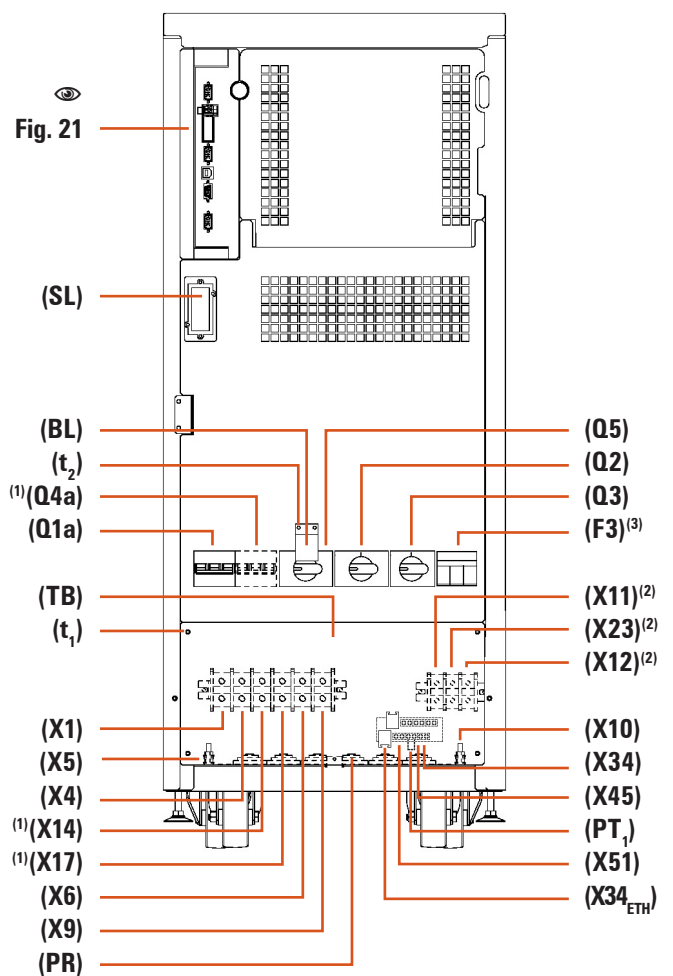

- (1) Equipments with separate static bypass line only (-B).
- (2) Equipments with extended back up time or 30 kVA (LV) / 60 kVA (HV) power rates only.
- (3) Battery protection in equipments with extended back up time only, where batteries are fitted in or ready to be fitted in part inside the own UPS cabinet.

Fig. 7. UPS front view with door opened, 5 to 30 kVA (LV) / 7.5 to 60 kVA (HV) models and II / II setting (L).

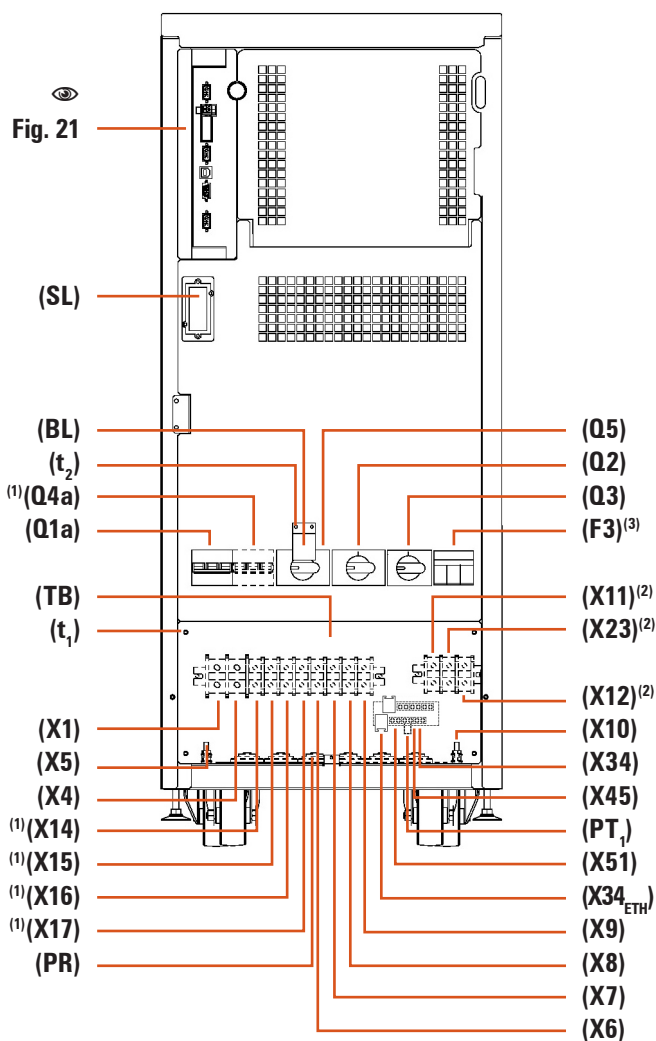

- ⁽¹⁾ Equipments with separate static bypass line only (-B).
- ⁽²⁾ Equipments with extended back up time or 30 kVA (LV) / 60 kVA (HV) power rates only.
- ⁽³⁾ Battery protection in equipments with extended back up time only, where batteries are fitted in or ready to be fitted in part inside the own UPS cabinet.

Fig. 8. UPS front view with front door opened, models from 5 to 30 kVA (LV) / 7.5 to 60 kVA (HV) and II / III setting (M).

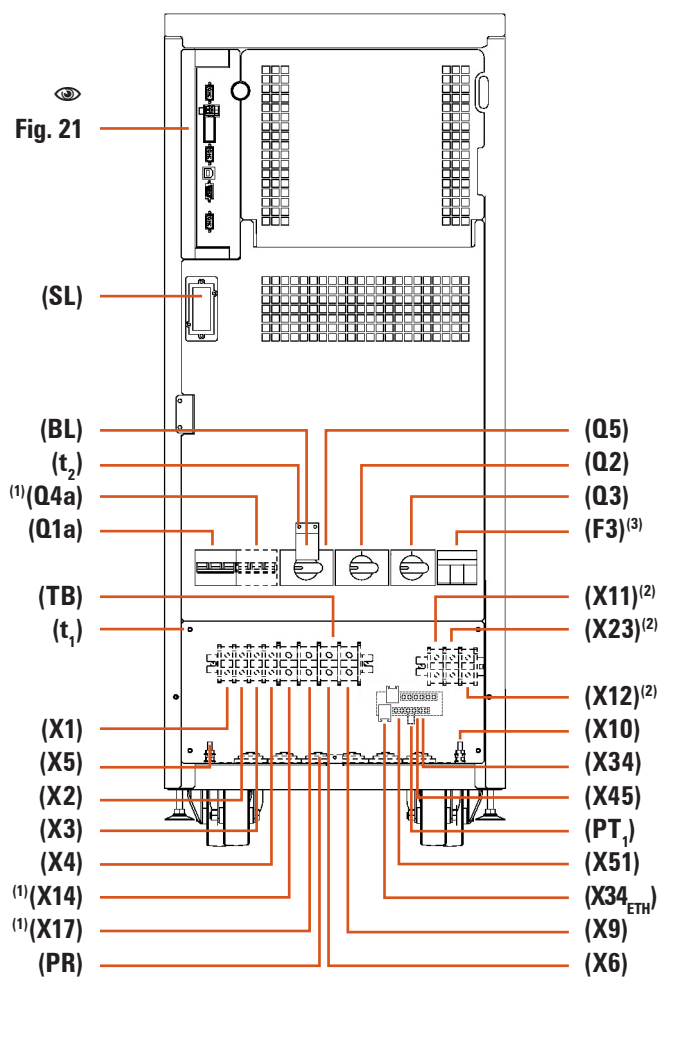

- ⁽¹⁾ Equipments with separate static bypass line only (-B).
- ⁽²⁾ Equipments with extended back up time or 30 kVA (LV) / 60 kVA (HV) power rates.
- ⁽³⁾ Battery protection in equipments with extended back up time only, where batteries are fitted in or ready to be fitted in part inside the own UPS cabinet.

Fig. 9. UPS front view with door opened, models from 5 to 30 kVA (LV) / 7.5 to 60 kVA (HV) and III / II setting (N).

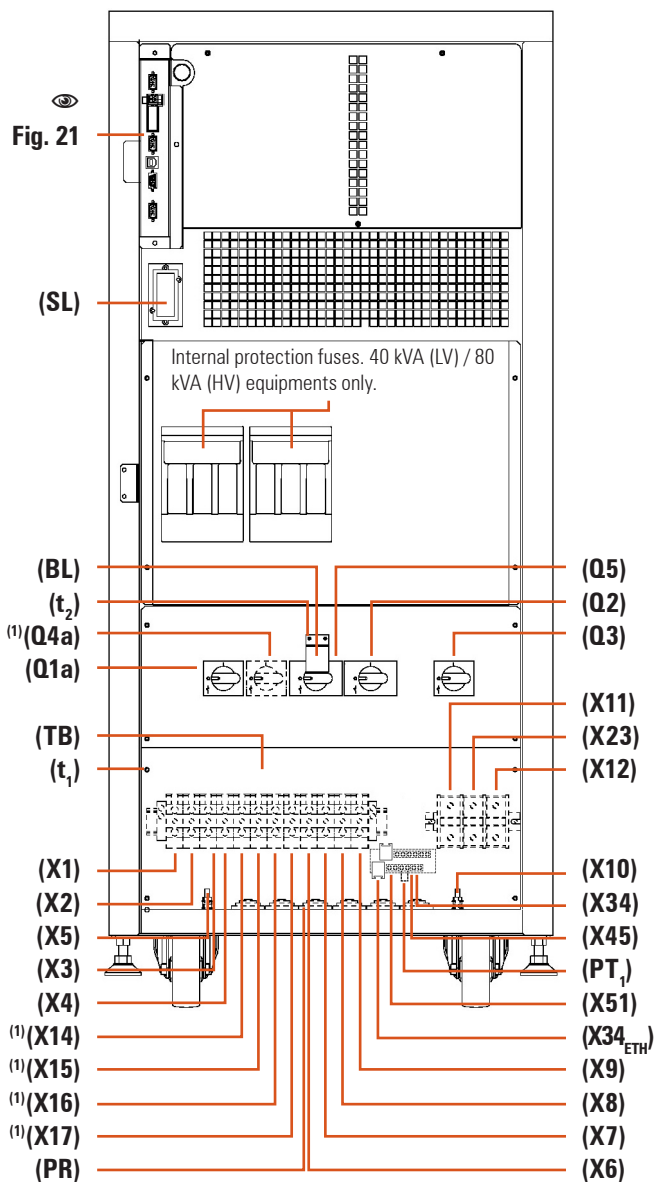

⁽¹⁾ Equipments with separate static bypass line only (-B).

Fig. 10. UPS front view with door opened, models 40 kVA (LV) / 80 kVA (HV) and III / III setting.

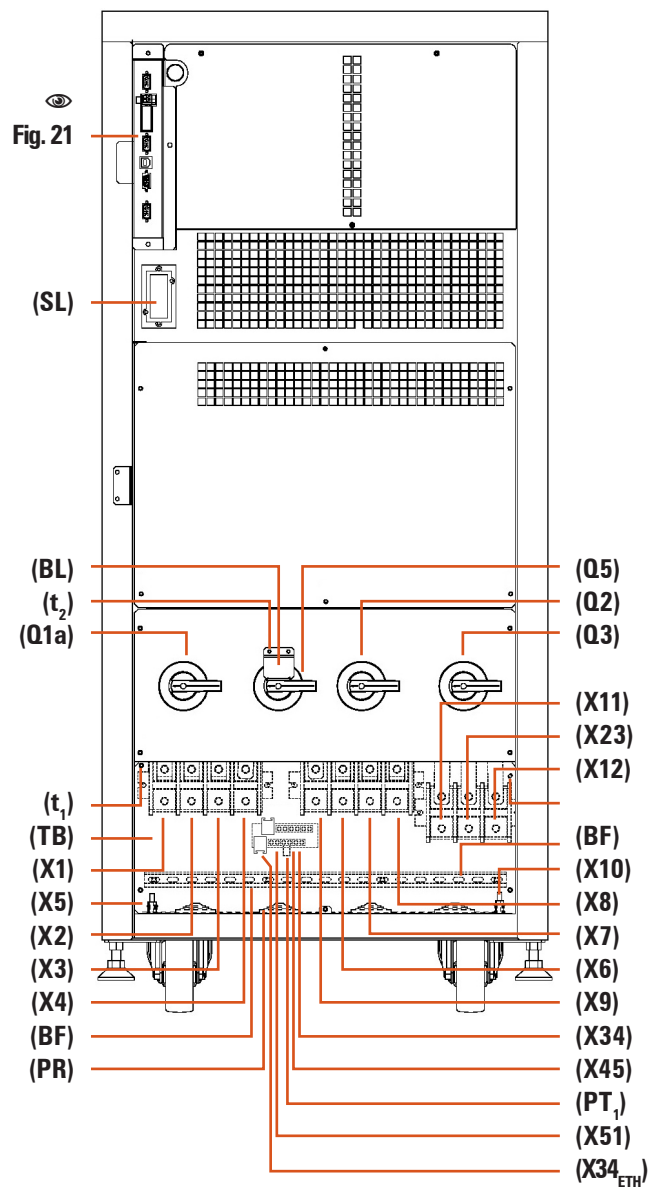

Fig. 11. UPS front view with door opened, models 50 and 60 kVA (LV) / 100 and 120 kVA (HV) and III / III setting, without separate static Bypass line.

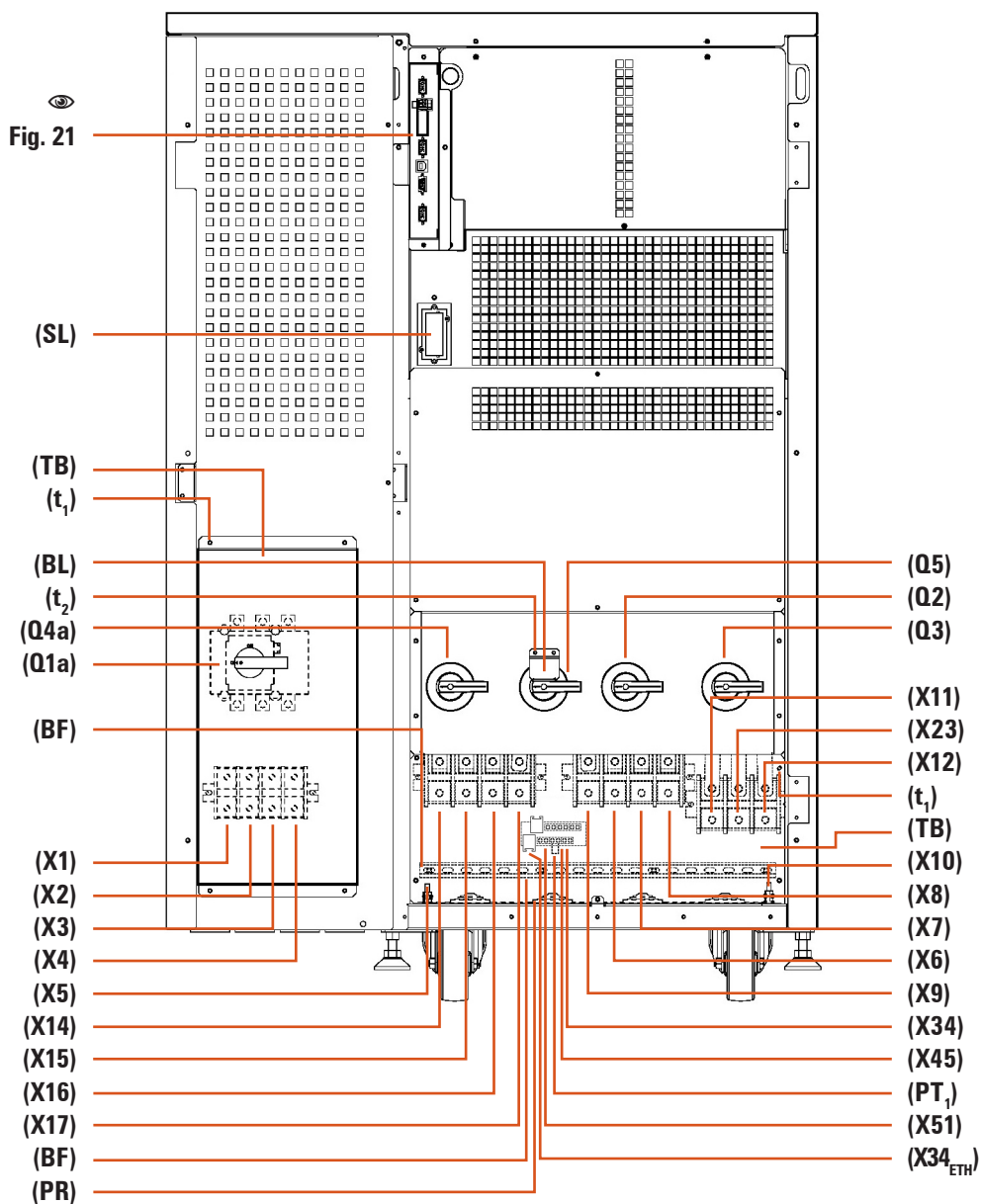

Fig. 12. UPS front view with door opened, models 50 and 60 kVA (LV) / 100 and 120 kVA (HV) and III / III setting, with separate static Bypass line (-B).

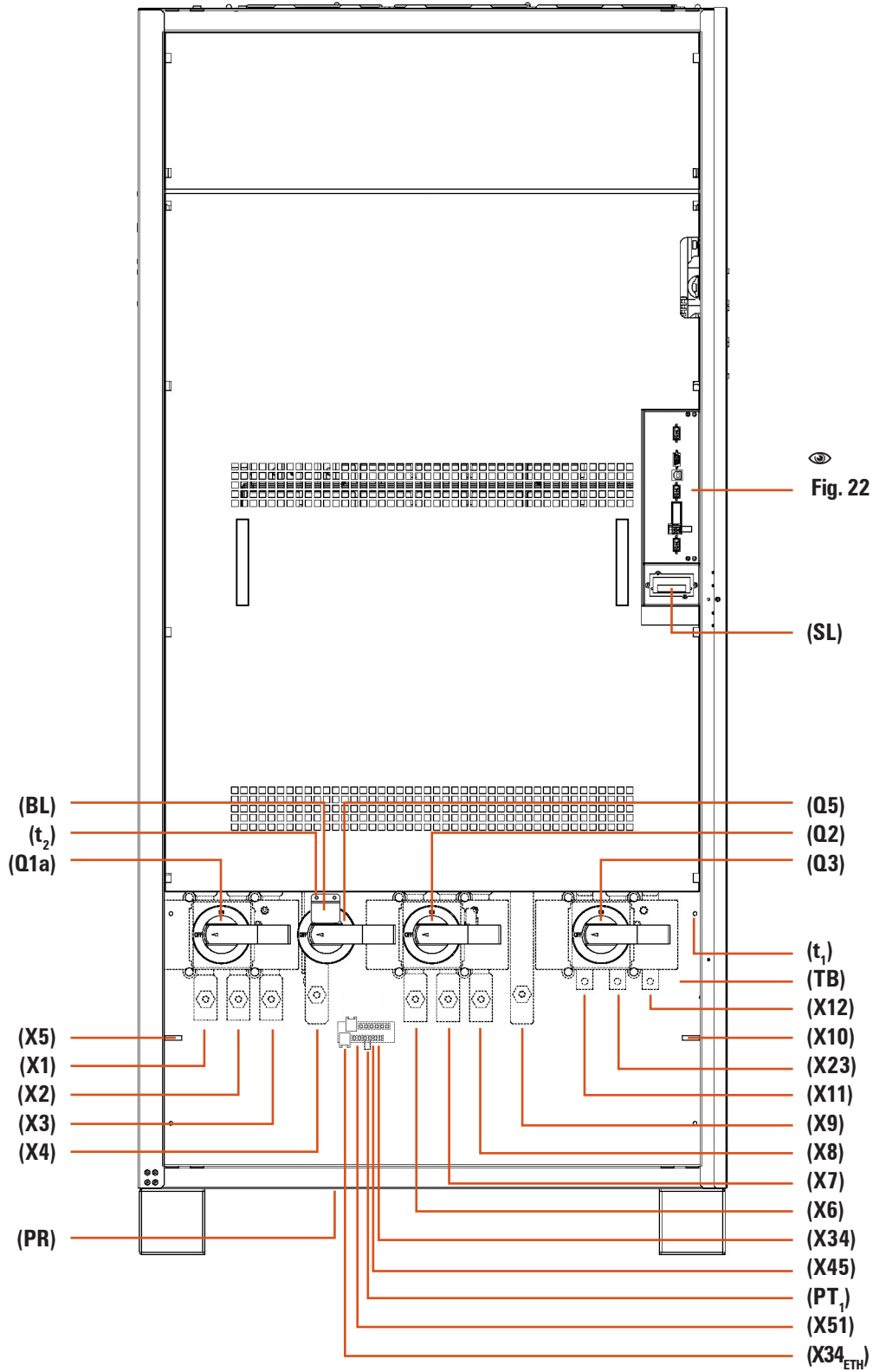
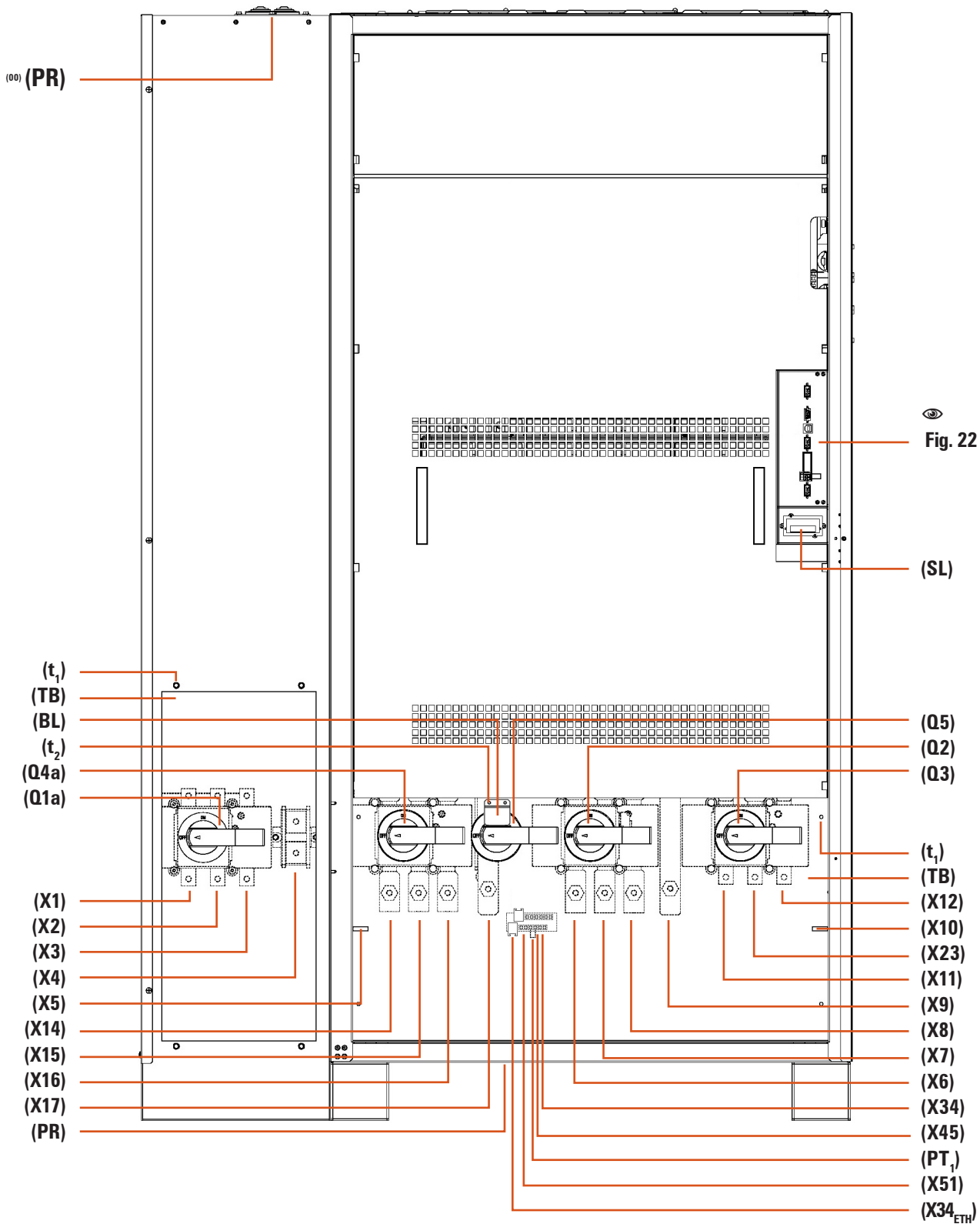

Fig. 22

Fig. 13. UPS front view with door opened, models 80 and 100 kVA (LV) / 160 and 200 kVA (HV) and III / III settings, without separate static Bypass line.



⁽⁰⁰⁾ Top entry cables (Optional).

Fig. 14. UPS front view with door opened, models 80 and 100 kVA (LV) / 160 and 200 kVA (HV) and III / III setting, with separate static Bypass line (-B).

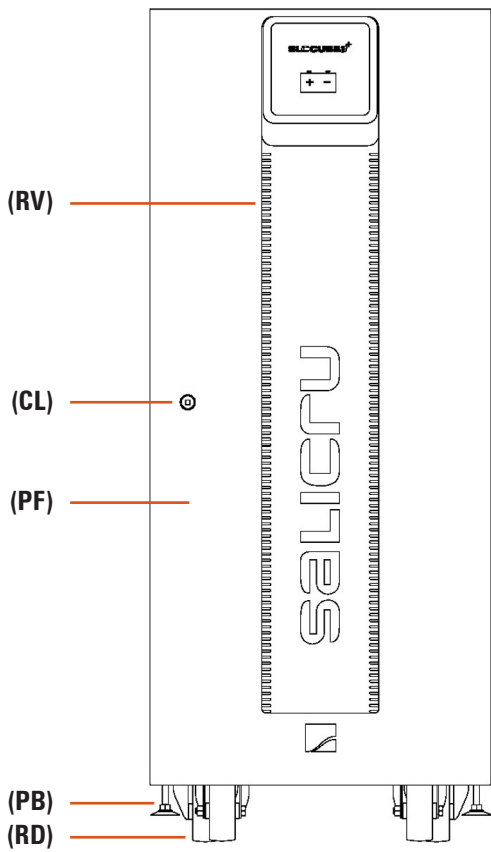

Fig. 15. Battery cabinet front view Nr 1, with door closed.

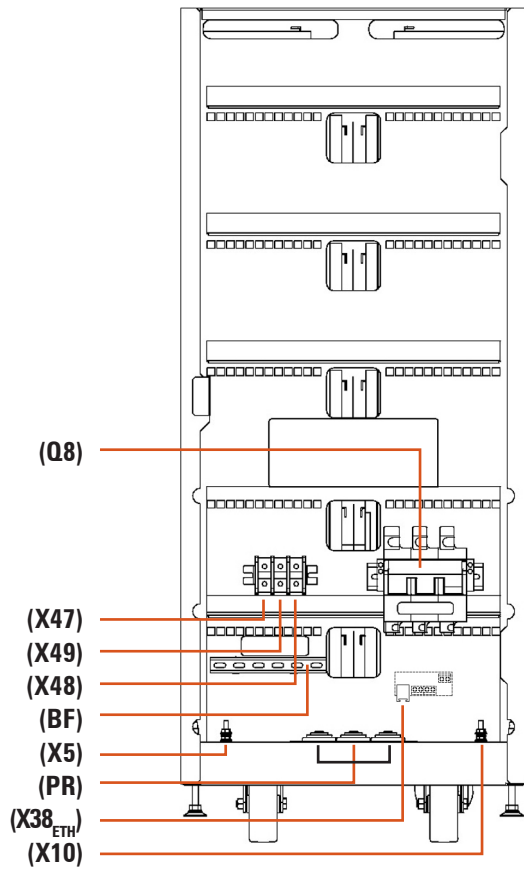

Fig. 16. Battery cabinet front view Nr 1, with door opened.

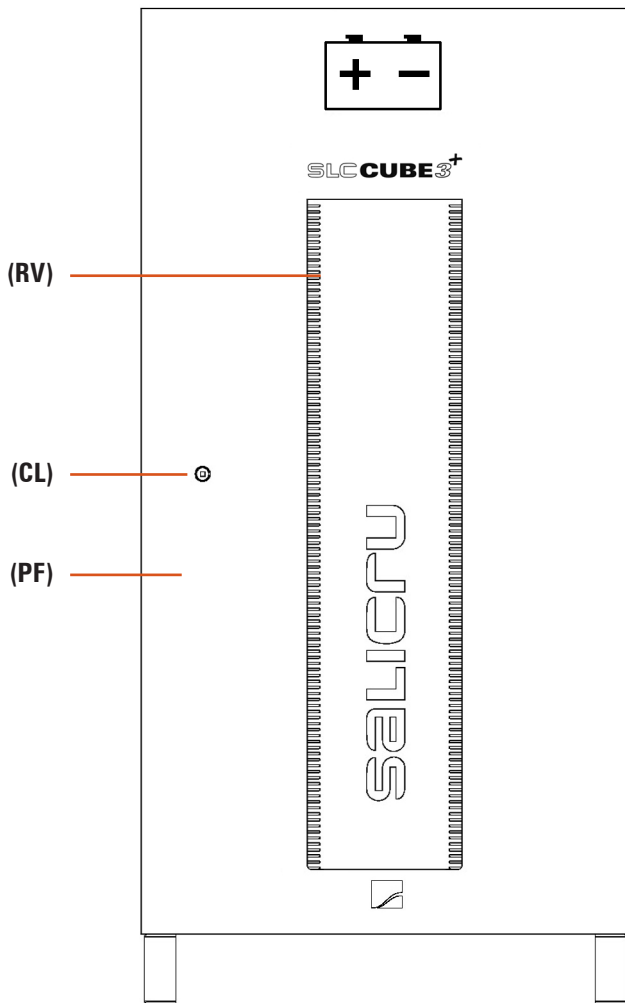

Fig. 17. Battery cabinet front view N° 2, with door closed.

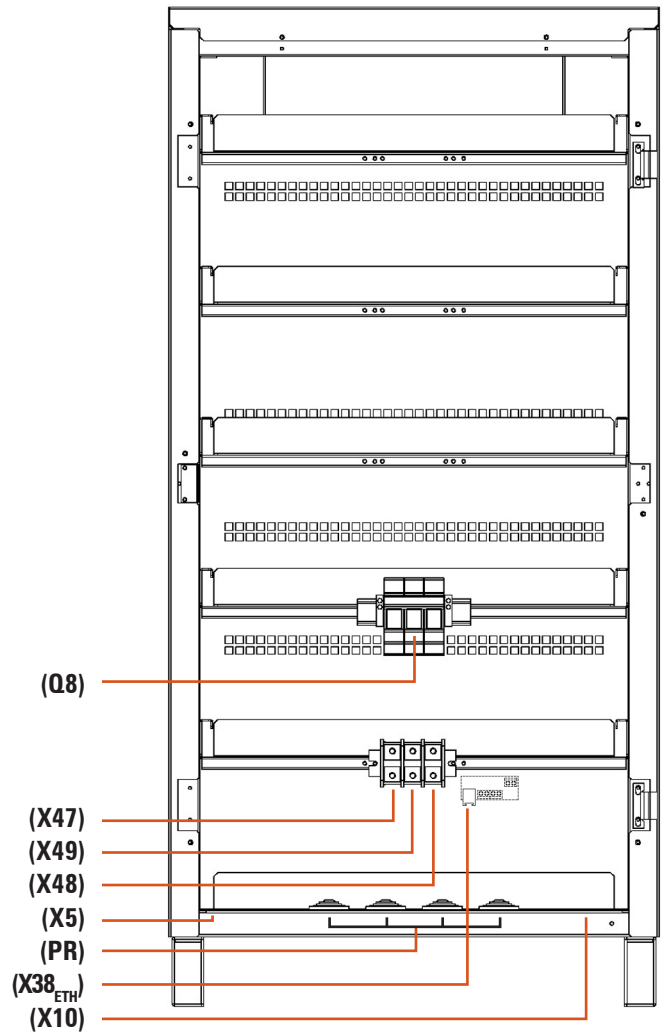

Fig. 18. Battery cabinet front view N° 2, with door opened.

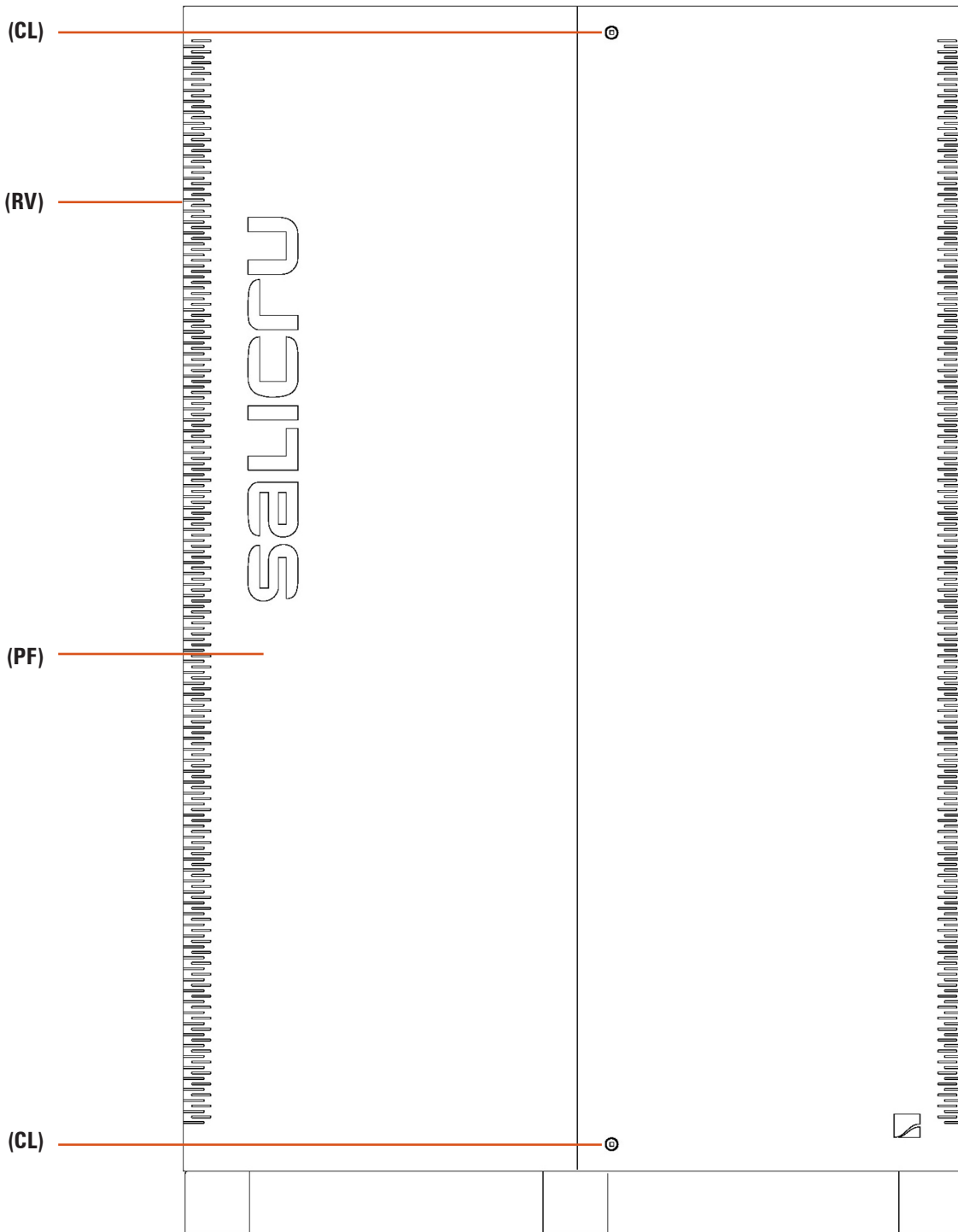

Fig. 19. Battery cabinet front view N° 3, with door closed.

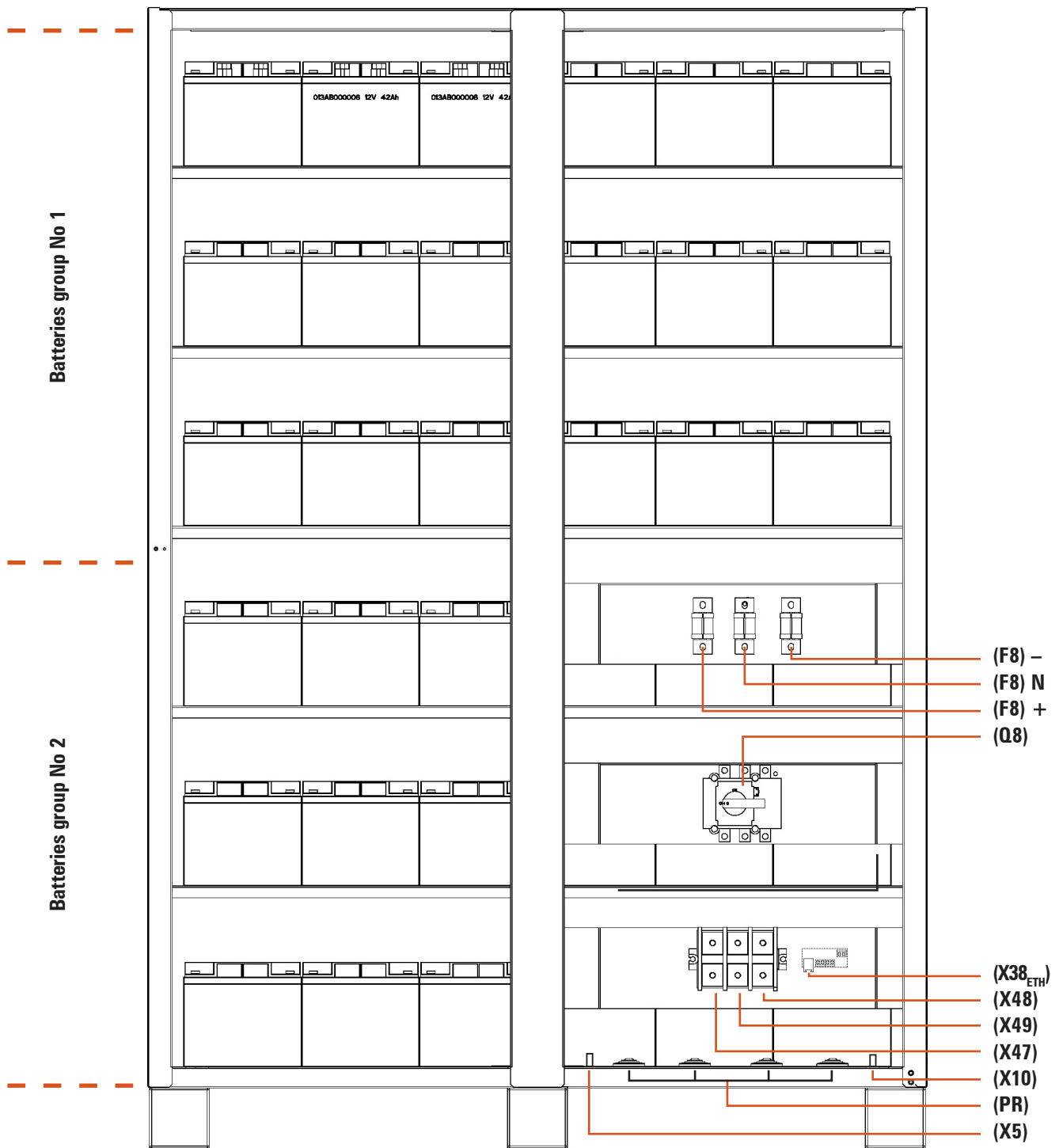

Fig. 20. Battery cabinet front view N° 3, with door opened.

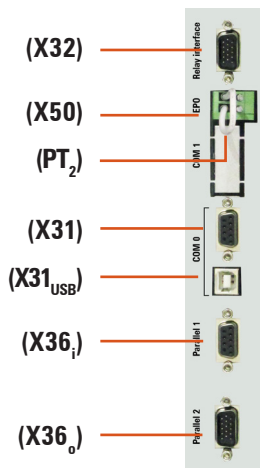

Fig. 21. Connection of communications for models up to 60 kVA (LV) / 120 kVA (HV).

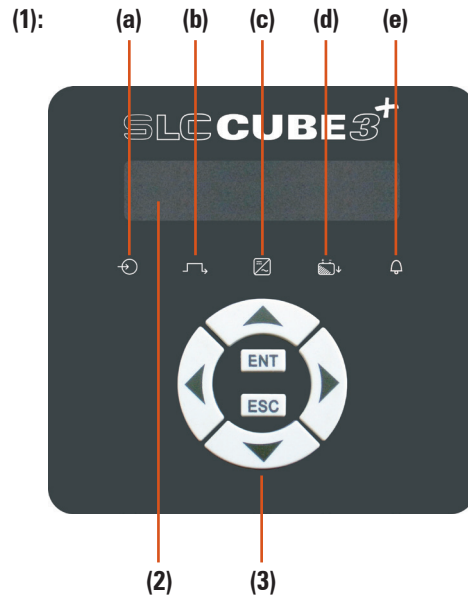

Fig. 23. Alphanumerical control panel (see section 7).

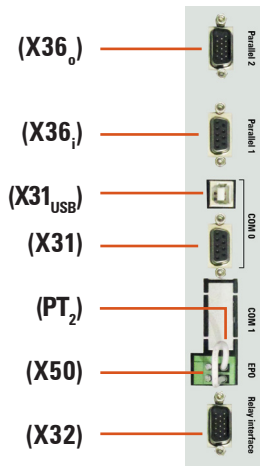

Fig. 22. Connection of communications for models higher than 60 kVA (LV) / 120 kVA (HV).

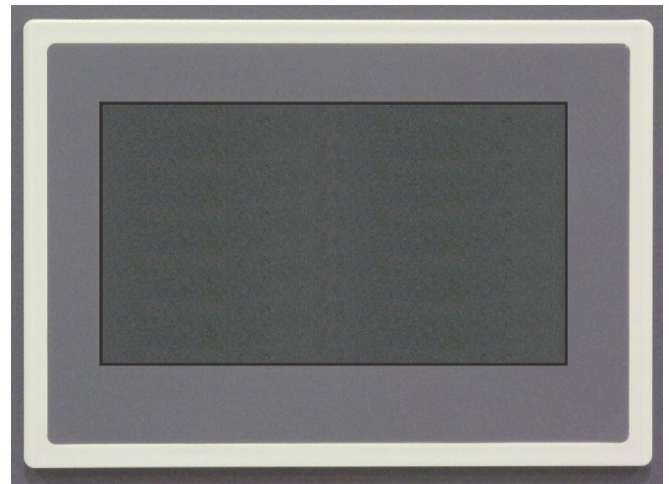

Fig. 24. Touchscreen control panel (see EL064*01 user's manual).

4.1.2 Legend corresponding to the equipment views.

Protection and manoeuvring parts (Q*) in the UPS cabinet:

- (Q1a)** Input circuit breaker or switch according to the equipment power rate.
- (Q2)** Output switch.
- (Q3)** Battery fuse holder switch with 3 fuses in models up to 20 kVA (LV) / 40 kVA (HV) or switch in models with higher power rate and/or B1 versions.
- (F3)** Battery fuse holder switch with 3 fuses. Up to 20 kVA (LV) / 40 kVA (HV) models with extended back up time, where the batteries are fitted in or ready to be fitted in part inside the own UPS cabinet.

- (Q4a)** Static bypass switch, two or three poles depending on the mains typology (-B version only).
- (Q5)** Manual bypass switch.

Protection and manoeuvring parts(Q*) in the battery cabinet:

- (Q8)** Battery fuse holder switch of 3 fuses, for models up to 60 kVA (LV) / 120 kVA (HV).
Battery switch, in models higher than 60 kVA (LV) / 120 kVA (HV). Also there are 3 fuses **(F8)** with no switch function, located inside the cabinet.

Connection parts (X*):

- (X1)** Terminal of input phase R.
- (X2)** Terminal of input phase S.
- (X3)** Terminal of input phase T.

- (X4) Terminal of input neutral N.
- (X5) Terminal (copper bar) of main earth (⚡).
- (X6) Terminal of output phase U.
- (X7) Terminal of output phase V.
- (X8) Terminal of output phase W.
- (X9) Terminal of output neutral N.
- (X10) Terminal (copper rod) of earth bonding for for battery cabinet and / or loads connected directly to the UPS terminals (⚡).
- ⁽⁴⁾ (X11) Battery positive terminal (+).
- ⁽⁴⁾ (X12) Battery negative terminal (-).
- (X14) Terminal of static bypass phase R (-B version only).
- (X15) Terminal of static bypass phase S (-B version only).
- (X16) Terminal of static bypass phase T (-B version only).
- (X17) Terminal of static bypass neutral N (-B version only).
- ⁽⁴⁾ (X23) Battery neutral N terminal (central tap).
- (X31) DB9 connector for COM 0 RS232/RS485 ports.
- (X31_{USB}) USB connector for COM 0 ports.
- (X32) DB9 connector for relay interface.
- (X34) Two terminal strip to connect the supplied 5 m. cable bundle, which has at its opposite end a temperature probe. This probe will be entered inside the battery cabinet in order to get the floating voltage compensation according to its internal ambient temperature.
- (X34_{ETH}) Ethernet connector, located in the BM630* electronic card and installed in the UPS, which makes the function of a terminal strip (X34) when the distance between cabinets (UPS and batteries) exceeds 5 m. In this case, the Ethernet connection (X38_{ETH}) located in the optional BM655* electronic card and fitted in the battery cabinet will be needed, in order to get the voltage compensation according to the temperature.
- (X36_i) HDB15 female connector, parallel bus input. Only useful in parallel systems connection.
- (X36_o) HDB15 male connector, parallel bus output. Only useful in parallel systems connection.
- (X38_{ETH}) Ethernet connector located in the optional BM655* electronic card, which is fitted in the battery cabinet. It allows the digital transmission from the collected information by the temperature probe fitted in the battery cabinet to the UPS, prior linking both connectors (X34_{ETH}) and (X38_{ETH}) with the cable.
- (X45) Two terminal strip, of the auxiliary contact of the output switch. To be connected with its external counterpart fitted in the manual bypass panel in parallel systems.
- (X47) Battery positive terminal (+) of the battery cabinet.
- (X48) Battery negative terminal (-) of the battery cabinet.
- (X49) Battery neutral terminal N of the battery cabinet (central tap).
- (X50) External EPO terminals.
- (X51) Terminal strip of two terminals, auxiliary contact of manual bypass switch. To be connected to its external homologous.

Control panel (PC), keypad and optical indicators:

- (LCD) LCD panel.
- (ENT) Key «ENTER».
- (ESC) Key «ESC».
- (↕) Key move up.

- (⬇) Key move down.
- (→) Key move to right.
- (←) Key move to left.
- (a) Rectifier input voltage correct (green led).
- (b) Output voltage of the equipment from bypass (orange led).
- (c) Inverter ON (green led).
- (d) Output voltage from batteries -mains fault- (red led).
- (e) General alarm of the equipment, it is triggered with any alarm (red led).

Other abbreviations:

- (BC) Communication BUS bundle between equipments, of 5 m. length with HDB15 connectors in both ends.
- (BF) Rod to fix the connection wires of the equipment or battery cabinet by means of wraps.
- (BL) Mechanical lock for manual bypass switch (Q5).
- (CL) Front door lock.
- (LL) Key to lock and unlock (CL).
- (PB) Levellers and fixing elements.
- (PC) Control panel.
- (PF) Front door.
- (PR) Cable gland or bushing to enter the cables.
- (PT₁) Cable as a bridge mode, which closes the electrical circuit between both pins of (X45), in case of lack of the auxiliary contact.
- (PT₂) Cable as a bridge mode, which closes the electrical circuit between both pins of (X50), in case of lack of the EPO button.
- (R103) Two wires bundle with probe, to control the floating voltage according to the temperature. Equipments with separate battery cabinet only.
- (RD) Casters.
- (RV) Cooling grid.
- (SL) Slot for SICRES card (option).
- (TB) Terminal cover -connection elements-.
- (t₁) Fixing screws for terminal cover (TB).
- (t₂) Fixing screws for mechanical locking (BL) of switch (Q5).

i ⁽⁴⁾ Battery terminals (X11), (X12) and (X23) available in models > 20 kVA (LV) / > 40 kVA (HV) only, or in equipments B1 type (extended back up time).

i By means of the connectors (X36_i) and (X36_o) the communication loop or ring is closed between two or more equipments connected in parallel, by means of the bundle (BC). These connectors are not useful when there is a single equipment only.

Together with each UPS, it is supplied only one bundle (BC) to connect the communication BUS. Therefore in any parallel system there will be the same quantity of communication bundles (BC) as equipments there are, so it makes possible to close the communication loop. Each communication bundle (BC) has 5 metres length and it is provided with HDB15 connectors at both ends, one male and another female.

4.2. DEFINITION AND STRUCTURE.

4.2.1. Nomenclature.

Equipment

SLC-10-CUBE3+ LBT-P2 B1 0/62AB147 AWCO "EE550714-2"

EE*	Particular client specifications.
CO	"Made in Spain" marking in UPS and packaging (for customs).
W	Neutral brand equipment.
A	For single phase mains 115.. 133 V or three phase 3x200.. 3x230 V.
147	Last three characters of the battery code (*).
AB	Letters of the battery family (*).
62	Quantity of batteries in one string (*).
0/	Ready for standard or extended back up time, without batteries but with the needed accessories to fit them in.
/	No batteries installed but with the needed accessories to install them. Batteries are supplied separately.
B1	Equipment ready to connect external batteries.
BC	Equipment ready to connect a common battery bank (2 UPS in parallel only). Omit for std back up time (internal battery inside the UPS cabinet only).
P2	Parallel system based on two equipments.
P3	Parallel system based on three equipments.
P4	Parallel system based on four equipments.
T	Top entry cables (160 and 200 kVA only).
B	Separate bypass line version.
L	Single phase input / single phase output setting.
M	Single phase input / three phase output setting.
N	Three phase input / single phase output setting.
	Three phase input / three phase output setting.
CUBE3+	Series.
10	Power in kVA.
SLC	Brand abbreviation for UPS.
CF	Frequency converter 50/60 or 60/50 Hz (**).

External batteries or extended back up times

MOD BAT CUBE3+ 0/2x62AB147/213 100A BC AWCO "EE550714-2"

EE*	Particular specifications of the client.
CO	"Made in Spain" marking in UPS and packaging (for customs).
W	Neutral brand equipment.
A	Battery set for mains 115.. 133 V or 3x200.. 3x230 V.
BC	Battery module for common bank (Parallel systems of two UPSs).
100A	Protection size.
213	Last three characters of the battery code type 2.
147	Last three characters of the battery code type 1.
AB	Letters of the battery family.
62	Quantity of batteries in one string.
2x	Quantity of battery strings in parallel. Omitted for one.
0/	Battery cabinet without batteries, but with the needed accessories to install them.
S/	Battery cabinet without batteries and without the needed accessories to install them.
/	Batteries not installed at factory, but with the needed accessories. Batteries are supplied separately.
CUBE3+	Series.
MOD BAT	Battery module or rack.



(B1) The equipment is supplied without batteries and without the accessories (bolts and electrical cables). It is foreseen that batteries will be fitted in an external cabinet or rack. Under request a cabinet or rack and needed accessories can be supplied.

For those equipments requested with no batteries, their acquisition, installation and connection will be always done by the client and **under his responsibility**. Nevertheless, the intervention of our **T.S.S.** can be required, in order to make all the installation and connection tasks.

Data regarding batteries like its quantity, capacity and voltage are stated in the battery label stucked beside the nameplate of the equipment, **respect this data strictly** and the polarity of the battery connection too.



In equipments with separate static bypass line, a galvanic isolation transformer has to be fit in any of both UPS power supply lines (rectifier input or static bypass), in order to avoid a direct connection of the neutral of both lines through the internal wiring of the equipment. This is only applicable, when both lines come from different mains, i.e.:

- Two different electrical companies.
- One electrical company and generator set, ...

(*) Equipments with batteries for an extended back up time.

(**) Frequency converters will not have either static bypass or manual bypass, although they have or not batteries.

4.2.2. Structural diagram.

To describe the operating principle, it is taken as a reference and example the single line diagram of Fig. 25 and 26, corresponding to **SLC CUBE3+** with three phase input and output setting, one with basic structure and the other one with separate bypass line.

All the equipments works and operates in the same way, although they have common line or separate static bypass.

4.3. UPS FUNCTION STAGES.

SLC CUBE3+ UPS series is structured in the following stages:

- I/O EMI filters.
- Rectifier-PFC (AC/DC).
- Batteries.
- Inverter (DC/AC).
- Static Bypass.
- Maintenance or manual Bypass.
- EPO emergency shutdown.
- Control panel.
- Control and communication Software.

4.3.1. I/O EMI filters.

EMI filter is a three phase low-band filter, which its function is to attenuate and cancel all the radio frequency perturbations. The filter performs in a bidirectional way:

- It cancels the perturbations that comes from the line and protect the UPS control circuits.
- It avoids the possible radio electrical perturbations that the UPS could generates flows through the line and affect to other equipments connected to it.

4.3.2. Rectifier-PFC stage (AC/DC).

Constructive parts:

- **Input protection and switch:** it is the particular protection of the PFC rectifier.
- **Current sensor:** it uses alternating current transformers to measure and control the input current, to get a THDi < 3% at full load condition and even < 1% depending on the quality of mains.
- **"T" filter:** it is used to attenuate the current ripple caused by the PFC switching.
- **IGBT's three phase bridge:** it will be used to make the AC/DC conversion with the lowest distortion and highest efficiency. To do that, it is used the Trench-gate IGBT technology of 4th generation.
- **Input chokes:** They are used by the PFC rectifier as energy storage elements (in switching times), for the AC/DC conversion.
- **DC Bus:** it is used to filter the DC needed for the correct operation of PFC converter and inverter.

4.3.3. Batteries.

SLC CUBE3+ UPS series has a battery set that stores energy during the normal operating mode (present mains) and they are discharged during the emergency operation (mains fault), keeping the critical loads running during the required time.

Batteries are sized to supply full power to the assigned critical loads during the back up time for any load condition. Standard batteries are sealed Lead Acid, maintenance free and VRLA technology.

Each cell or cell group (battery block) are duly marked in a permanent way, with polarity indication, voltage and safety warning required by the standard.

Cells are duly assembled and electrically connected. Battery set is protected by means of a fuse holder with ultra fast fuses, ready for the described conditions in section «4.3.2. Rectifier-PFC stage».

In normal operation (mains present and charged batteries), the battery set is working on floating voltage.

As an option the battery set of Pb-Ca or Ni-Cd can be assembled in a cabinet or rack separately from the equipment, shared for systems made of two UPSs in parallel.

4.3.4. Inverter stage (DC/AC).

Constructive parts:

- **DC Bus:** it is used to filter the DC and it is in charge of interconnecting the PFC and Inverter through the protection fuses.
- **IGBT three phase inverter bridge:** it is equal to the PFC stage but in counter way, it is in charge of making the DC/AC conversion with the lowest distortion and highest efficiency. It is also using the Trench-gate technology of 4th generation.
- **Current sensor:** as it has been described before, in this case conventional AC currents sensors are also used (current transformers) for measurement and control the output current of the inverter to get a total harmonic distortion at the output voltage lower than 1% in full load conditions.
- **Output chokes:** it is used an identical solution as the used at the input. These chokes are used by the inverter as energy storage elements (in switching times), for DC/AC conversion.

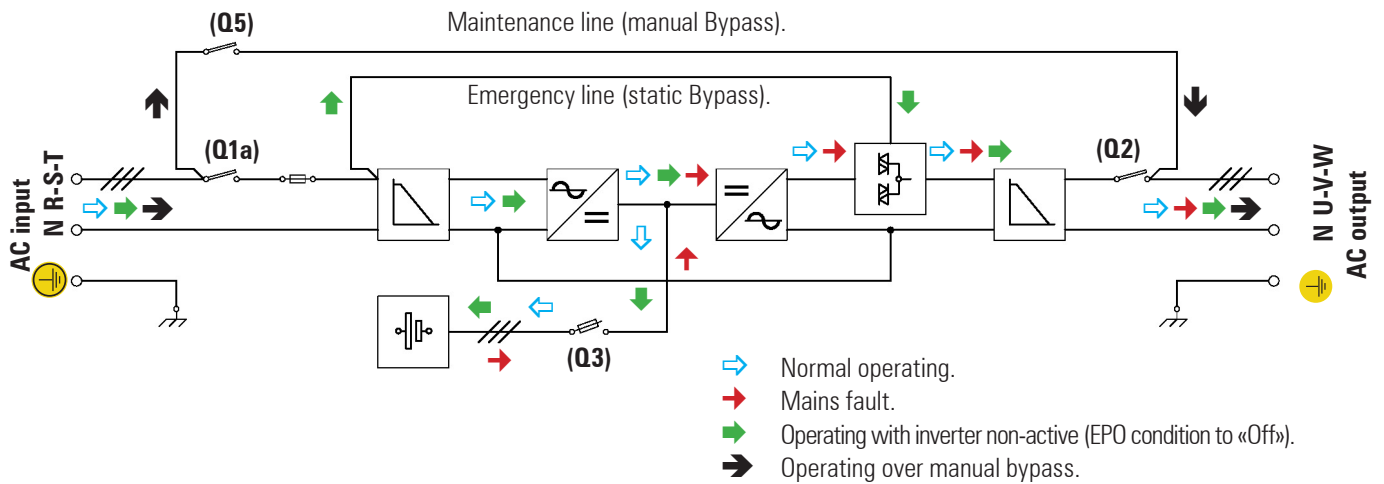

Fig. 25. SLC CUBE3+ UPS single line diagram with operating flows.

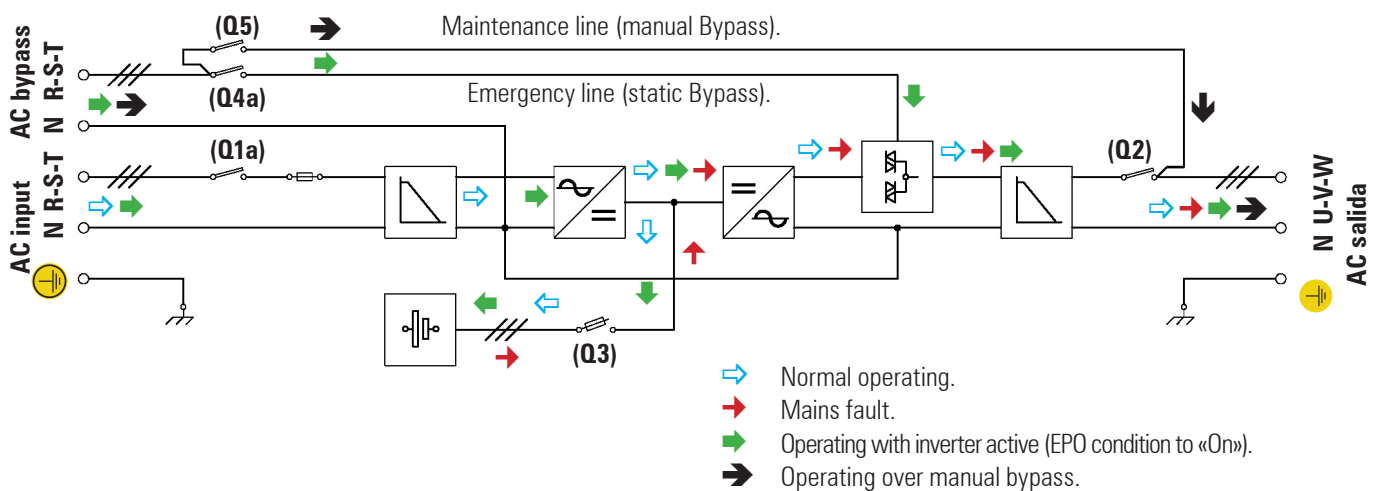

Fig. 26. SLC CUBE3+ B UPS single line diagram with operating flows.

4.3.5. Static bypass stage.

When the inverter can't keep the voltage to the critical loads due to overloads, short-circuits, current limits or faults, the UPS from **SLC CUBE3+** series has a bypass circuit, which supplies isolation for the inverter and supplies the critical loads directly from electrical mains.

The UPS controls the availability inverter-bypass permanently in order to make the shifting between them.

The bypass stage is based on six double thyristors in semipack format, working as AC switches, three of them are for shifting the input over the output and the other three are for shifting the inverter over the output.

The managing system of the SCR switches is based on drivers designed with a shifting system that responds to the following requirements:

- Full static shifting system.
- Shifting with no high transient currents.
- Shifting with no transfer time.

The control algorithm of the triggering signals of the thyristors assures a nil transfer time, and avoids short-circuits between the thyristors of bypass and inverter (shifting with zero cross current).

4.3.6. Maintenance or manual Bypass.

UPSs from **SLC CUBE3+** series are foreseen with an auxiliary line protected by a circuit breaker switch, which makes an electrical bridge between the input and output terminals.

Managing this switch, properly together with the input and output, allows isolating electrically all the UPS elements from the electrical lines.

The type of manoeuvring of the maintenance bypass is "make before break", with the purpose of keeping the critical loads fed, even during the maintenance tasks.

4.3.7. Terminals for EPO.

The UPS has two terminals to install an external button of emergency output shutdown (EPO).

4.3.8. Control panel.

The UPS from **SLC CUBE3+** series has a sophisticated control panel managed by a microcontroller, which acts as a interface mode between the UPS and the end-user.

Depending on the model, it is equipped with an alphanumeric panel or touchscreen. Automatically, both devices informs to the end-user about the current status of the equipment and the electrical measurements by means of a tree menu, allowing an easy browsing through their screens.

4.3.9. Control software and communications.

AFC Control (Adaptive Feedforward Cancellation).

It consists in the use of digital resonators connected in parallel and set to those frequencies where the consigns or perturbations to refuse are expected.

This control technique allows doing the follow of the sinewave signals of reference of the output voltage in the inverter and input current of the active rectifier.

It is important to highlight that the different controls of the UPS do not operate either isolated or locally, but they interact between them in such way that it results a global controller of coupled type. It means operating advantages like to adapt the rectifier to the load conditions immediately.

The digital control software works at two different levels:

4.3.9.1. Control software at low level.

- **Input three phase rectifier controller:** PFC control and battery charge loops. The structure adopted of independent control per phase of cascade type allows managing both single phase and three phase inputs.

The AFC control technique has been also applied, to assure a sinewave mains currents, with a THDi < 2%, and in phase shifting with the voltages, to balance the active power of all the system, to accelerate its response and make it insensitive against the load transients.

In normal conditions, the rectifier is running and charging the batteries, controlling at any moment the charging current and floating voltage according to the temperature of themselves. The system is also in charge of minimising the charging current ripple that flows through them.

When the input voltage or frequency is out of the correct operating range, it is shutdown and batteries are responsible of keeping the inverter in operation, which at the same time supplies the loads connected at the output of the equipment till the battery voltage decreases till the end of back up time.

Another important feature of the rectifier is its bidirectional capacity of operation. This allow consigning a battery discharging current even with mains present. This quality performance will make possible to do a battery test both in full load and no load conditions.

- **Output three phase rectifier controller:** independent per phase, it is easy adapted to different settings, either single phase or three phase.

It is highlighted the use of the AFC control technique that allows getting an output voltage with a THDv lower than 1,5% with non-linear load at the output and good dynamic response against unexpected step loads.

- **Switching algorithm of the bypass thyristors.**
- **Parallel control:** high speed communication and inverter parallel connection.

4.3.9.2. Managing software of the equipment.

- Managing and control of different parts.
- Visualisation software for user interface.
- Software of communication and protocol implementation.
- Managing software of parallel system.

4.3.9.3. Communications.

- **COM port to relays:** It supplies a digital signals in a dry contact way, which makes possible the dialogue between the equipment and other machines or devices.

By default the equipment is supplied with 4 signal relays with a preset programming (see chart 3), which can be modified at factory or by the **T.S.S.** under request. Chart 7 shows all the alarms that can be set to any relay. A fifth relay can be supplied as an option and under request, which can be defined in the purchase order.

Also there is a "shutdown" input that allows shutdown the inverter.

The most common use of this type of port is to supply the needed information to the closing file software.

- **USB port:** The equipments includes a connection by means of Type-B connector, USB port, performing as a virtual serial port («Virtual COM Port», or «VCP»). When connecting the PC to such port, the «VCP» «driver» will be automatically installed, so the USB port will perform as a COM 0 serial port of the equipment.

The connection of a PC to the USB port of the UPS, disables the operation of the COM 0 port through the RS232/RS485 too. So, it means, that the USB communication has priority over the RS232/RS485.

The standard protocol for this port is Modbus, the same one as for the RS232/RS485.

- **COM port RS232/RS485:** By means of the same DB9 connector supplies the RS232/RS485 communication ports. They are mutually exclusive between them and they are used to connect the UPS with any machine or device that has this standard bus.

The **RS232** port consists in the serial transmission of data, in such way that it can send a lot of information through a communication cable of 3 wires.

The **RS485**, unlike other serial communication channels, it uses 2 wires only to dialogue among the systems connected to this network. The communication is established by sending and receiving signals in differential mode, so it gives to the system

high immunity to the noise and long range (approx. 800m).

The used protocol is "MASTER/SLAVE" type. The computer or IT system ("MASTER") asks for a determined data, and the UPS answers immediately ("SLAVE").

4.4. OPERATING PRINCIPLE OF AN EQUIPMENT.

UPS from **SLC CUBE3+** series is a double conversion system AC/DC, DC/AC with sinewave output that supplies a safe protection in extreme conditions of electrical power supply (fluctuations of voltage, frequency, electrical noises, blackouts and mains faults, etc...). Whatever the type of load to protect is, these equipments are ready to assure the quality and uninterruptible electrical power supply.

The use of the transformerless technology allows a significant reduction of weight and volume in the equipments, by improving a lot important coefficients like the power/footprint ratio.

- Basically its operating is the following:
 - ❑ The rectifier, an IGBT three phase rectifier, converts the AC voltage in DC by draining a sinewave current (THDi <2%), charging the batteries with constant current/voltage.
 - ❑ Batteries, Pb-Ca by default, supply the required energy by the inverter in case of mains fault. The equipment can support AGM, Gel or Ni-Cd batteries. For the last two type of batteries, the equipment includes a double level charger.
 - ❑ The inverter is in charge of converting the DC bus voltage into AC providing an alternating sinewave output, stabilised in voltage and frequency, ready to supply the loads connected at the output.
 - ❑ The basic structure of double conversion is complemented with two new functional stages, static bypass switch and manual bypass switch.
 - ❑ The static bypass switch connects the output load with bypass line directly in special conditions like overload or over temperature and it is reconnected to inverter again, once the normal conditions are restored.
 - ❑ **SLC CUBE3+ B** version has two separate lines for the rectifier and bypass stages increasing in the safety of the installation, because it allows the use of a second line (generator set, other company, etc...).
 - ❑ The manual bypass switch isolates the UPS from mains and loads connected at the output, so the maintenance tasks can be done inside the UPS without interrupting the supply to the loads.

4.4.1. Normal operating (⇒).

With mains present, the rectifier converts the AC input voltage into DC, by boosting the DC voltage to an optimal level to feed the inverter and battery charger.

The inverter is in charge of converting the DC bus voltage into AC providing an alternating sinewave output, it stabilises the voltage and frequency, ready to supply the loads connected at the output (Fig. 25 and 26).

4.4.2. Mains fault operating (⇒).

In case of mains fault or blackout, the battery set supplies the needed energy to feed the inverter.

The inverter still operates normally, without noticing the lack of mains and the back up time depends in the capacity of the battery set only (Fig. 25 and 26).

When the battery voltage reaches the low voltage, the control blocks the output in order to protect the batteries from being deep discharged. When mains is restored and after the first seconds of analysis, the UPS goes back to operate as it is described in the previous section «4.4.1. Normal operating».

When mains is restored after a blackout, it is activated the rectifier soft start according to the «Walk-in Time» setting (10 sec. by default), which later one can be set between 0 and 99 sec. by our **T.S.S.**, considering that figure 0 is disabled.

Also another parameter that manages the rectifier is the start up delay «Walk-in Delay» (5 sec. by default and setable between 0 sec. and 1 h). This functionality is very useful in installations where the UPS is supplied by a generator set and it is required to wait to start up till having a stabilized voltage and frequency.

Schematically, the operating is as follows:



4.4.3. Operating with non-active inverter (⇒).

The inverter is non-active due to alarm conditions like overloads, over temperatures, etc... In this case the rectifier is still charging the batteries in order to keep their optimal charge status.

The inverter is also non-active if the start up has not been done through the keypad of the control.

In both cases, the output voltage of the UPS comes from the emergency bypass line through the static bypass switch (Fig. 25 and 26), on condition that the EPO is inactive.

4.4.4. Manual bypass operating (⇒).

When it is required to make any maintenance service to the equipment, it can be disconnected from mains without breaking the power supply of the system and affecting it to the critical load. The UPS can only be intervened by technical or maintenance staff, by means of the manual bypass switch (respect the corresponding operative instructions later on stated).

4.4.5. Smart ECO Mode operating (⇒/⇨).

For those applications with lower requirements, the smart and efficient function «Smart ECO Mode», meanwhile the power supply is available, allows the equipment feeding the loads directly from mains through the solid state static bypass («Off Line» mode).

In case of mains fault, the system will automatically shift to normal operating mode («On Line») and will supply the loads through the inverter with the energy of the batteries. The «Smart ECO Mode» operating mode improve the efficiencies between 4 and 4,5 % highest than «On Line» normal mode, so it is close to 100 %.

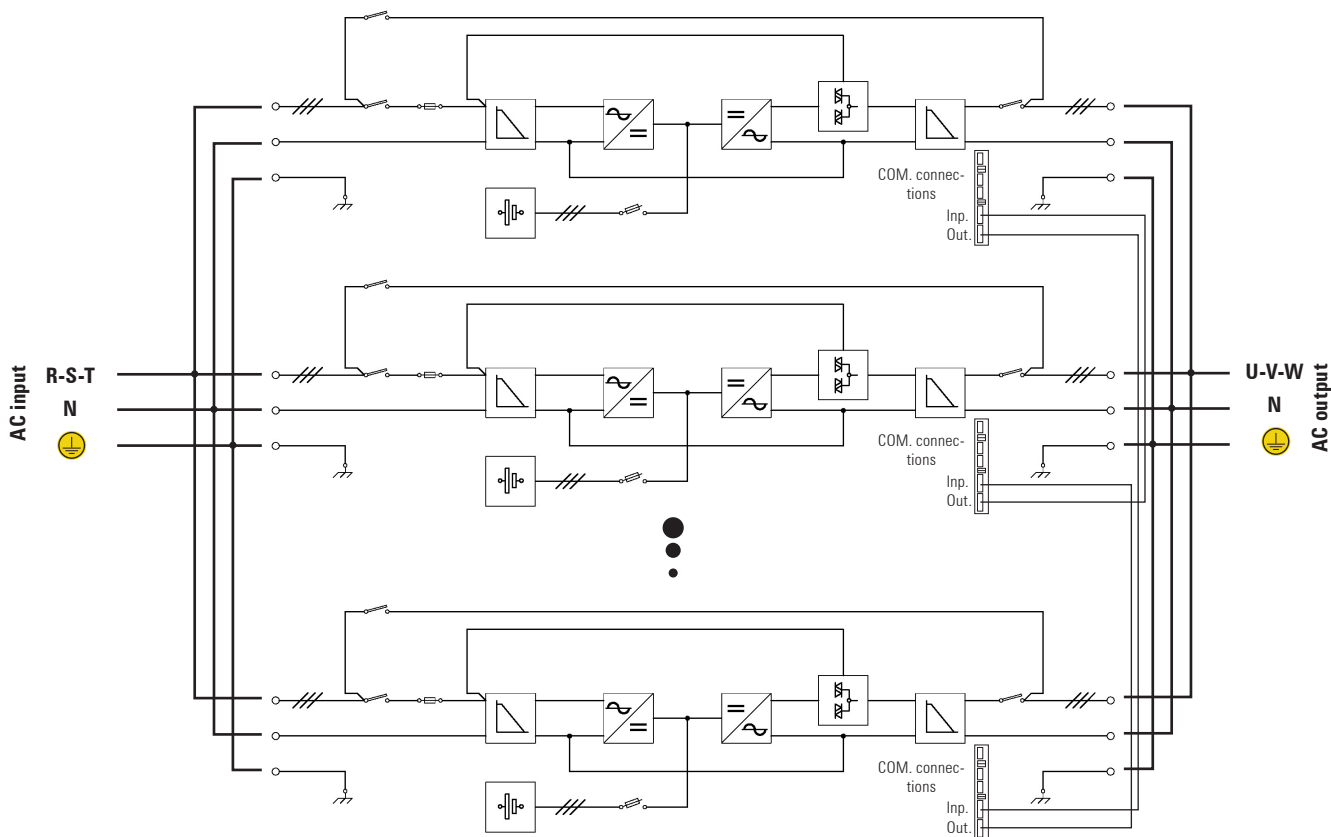

Fig. 27. Single line diagram, connection of parallel system up to 4 SLC CUBE3+ equipments.

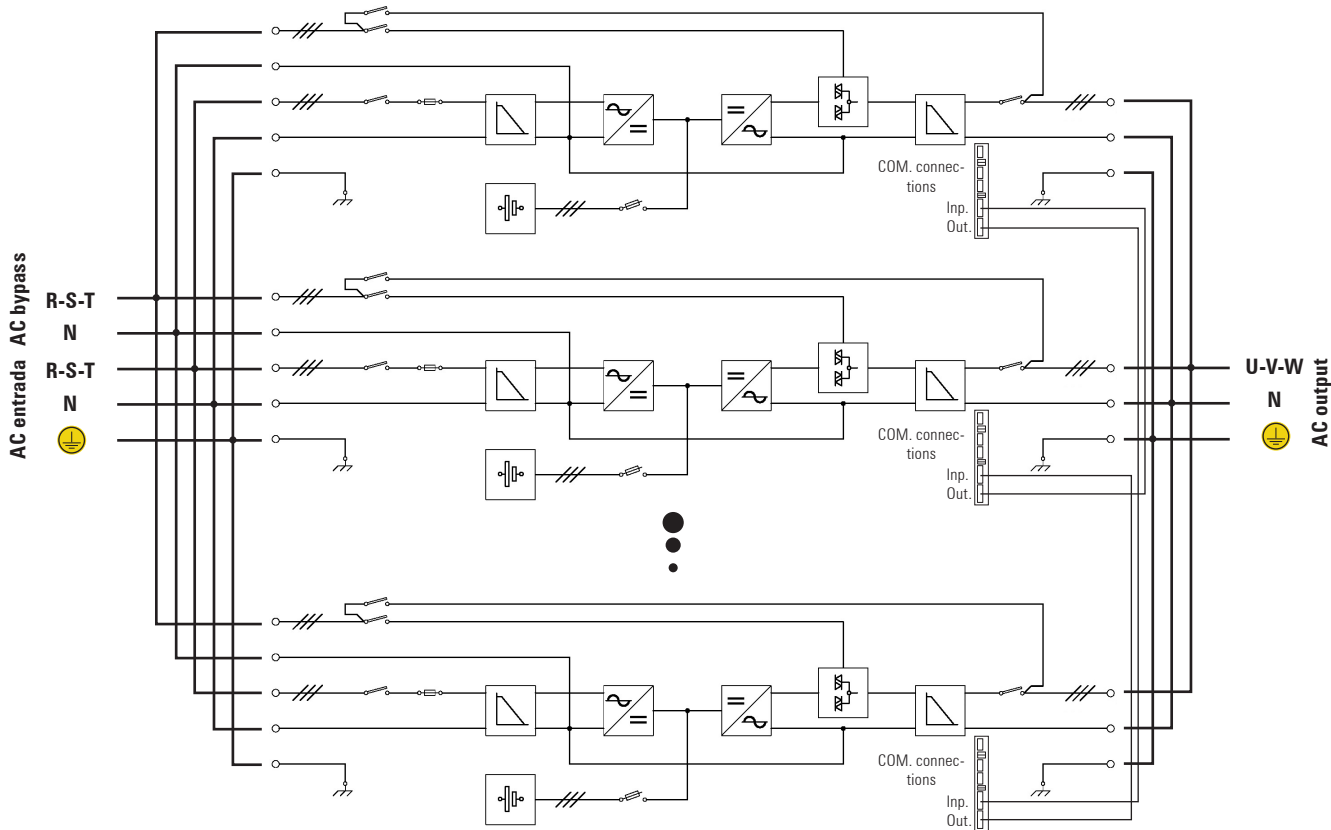

Fig. 28. Single line diagram, connection of parallel system up to 4 SLC CUBE3+ B equipments.

The «Smart ECO Mode» operating does not ensure a perfect stabilisation in frequency, voltage or sinewave shape (distortion) as in «On Line» normal mode, because the figures of these parameters depend on the static bypass line and preset activation ranges completely.

The detection of these parameters can take up to 3 ms, so it is recommended to assess the advisability of using this operating mode, depending on the level of protection required by the loads.

This operating mode is disabled from factory and the end/user can activate it, in case it were needed, according to section 7.3.2. and Fig. 45.

4.4.6. Frequency converter operating.

SLC CUBE3+ can be set from factory as frequency converters, whether they has batteries or not, being able to operate from 50 to 60 Hz or vice versa.

The equipments set as frequency converters, the static bypass and manual bypass are not available.

So, those functions, measurements, alarm messages, parameter settings, as well as manoeuvring of the related switches will not be operative and they will not be taken into account.

4.5. OPERATING STRUCTURE OF A PARALLEL SYSTEM.

The Uninterruptible Power Supply Systems **SLC CUBE3+** series, are designed and thought for its «parallel» connection with a maximum of four units, on condition that they are the same model (setting, voltage, power, frequency, back up time, ...), all of them without adding hardware. Fig. 27 and 28, as an example, show the circuit diagrams of a three phase/three phase parallel system, with and without separate static bypass line. Both circuit diagrams are only showing the input-output power connections and the parallel control BUS.

A part from the possible setting, conceptually, the parallel systems are divided in two similar structures and at the same time very different depending on the application.

Systems connected in parallel or active parallel, supply the loads equally among them. Less when there is only one UPS, the system will be able to be redundant or non-redundant depending on the needs and requirements of the application.

- **Simple parallel system (non-redundant):** a non-redundant parallel system, is that one where all UPSs supply the required power by the loads. Total power of the system based on N equipments of nominal power rate P_n , is $N \times P_n$.

If the system is operating with a load close or equal to the maximum and one of them faults, the load will be shifted to bypass automatically with make before break technique, because it will not be able to support the consumption demand due to the overload that it will be caused in the rest of UPSs.

- **Redundant system:** a redundant system is that one has one or more UPSs than the minimum required by the total power of the system (depending on the redundancy level), being the load fair shared among them. So, the fault of any of them will cause that the damaged UPS will be out of the system and the rest will continue supplying the load with all the guarantees. Once the damaged UPS is fixed, it can be connected to the system in order to recover the redundant condition.

A system with his configuration increases the reliability and assures an AC power supply of quality for the most critical loads.

The quantity of redundant equipments to be connected has to be studied according to the requirements of the application.

Parallel connection, redundant or not, adds several advantages a part from the connection itself:

- **Higher punctual power and back up time:** in a parallel system of N+M equipments, it is considered the nominal maximum load of N equipments and +M are the reserve ones, so:
 - ☐ N, is the quantity of equipments in parallel, corresponding to the minimum quantity required by the total needed power.
 - ☐ +M, is the additional quantity of equipments corresponding to the residual safety power (redundant equipments).

Although, in practice it can drain the total power in that the N+M system can supply, the redundancy requirement or conception does not advice it and in compensation there is a surplus of dynamic power against load demands.

I.e., a redundant parallel system with 3 UPS of 40 kVA and N+1 configuration, the nominal maximum load contemplates 80 kVA (2x40 kVA), although the system can accept load demands up to 120 kVA (3x40 kVA).

Therefore, the fact of having +M reserve equipments, increases the back up time of the set, because the battery set is higher.

- **Modularity:** capacity can be added to a UPS parallel system by adding equipments of the same feature, without needing to replace the equipments already installed.

I.e., if time later, an installation with a parallel system of 2 UPSs is detected that the capacity of this system is not enough, it can be opted for adding a third equipment to the system, without replacing the 2 original equipments.

The UPS parallel system management of **SLC CUBE3+** series is done by a MASTER-SLAVES protocol, where only one equipment (MASTER) takes the control of the rest ones (SLAVES). So, the control of the output voltage, bypass shifting, disconnections, mains synchronisation, ...; are managed by the MASTER equipment, and transmitted to the SLAVES equipments through the management bus of the parallel system.

This MASTER or SLAVE condition is dynamic as it is described later and it will depend on several factors (initial status of the equipments, chronological order of commissioning or shutdown of the system through one equipment or other one, ...)

5. INSTALLATION.

-  Read and respect the Safety Information, described in section 2 of this document. To obviate some of the indications stated in it, can cause a serious or very serious injuries to persons in direct contact or in the vicinity, as well as breakdowns in the equipment and/or loads connected to itself.

As well as the own user's manual of the equipment, other annex documents are supplied in the documentation CD/Pendrive. Consult them and follow the described procedure strictly.

- Unless the opposite is indicated, any action, indications, premises, notes and others, are applicable to **SLC CUBE3+** equipments, that belong or not to a parallel system.

5.1. RECEPTION OF THE EQUIPMENT.

-  It is dangerous to handle the equipment over the pallet with not much prudent, because it could overturn and cause serious or very serious injuries to the operators due to impact of the possible fall and/or trapping. Regarding the equipment handling, moving and location pay attention to section 1.2.1. from safety instructions -EK266*08-.
- Use the most suitable medium to move the UPS meanwhile is packaged, with a pallet truck or fork lifting.
- Any equipment handling will be done paying attention to the weights according to the model stated in the technical specifications of section «9. Annexes».

5.1.1. Reception, packaging and contents.

- Reception. To check:
 - Data in the label stucked in the packaging corresponds to the ones stated in the purchase order. Once the UPS is unpacked, check the previous data with the one in the nameplate of the equipment, stucked at the back of the front door (PF).

If discrepancies exist, make the nonconformity as soon as possible, by quoting the serial number of the equipment and the references of the delivery note.

 - No incident has happened during the transport (packaging and impact indicator are in perfect status).

Otherwise, follow the protocol stated in the label attached to the impact indicator, located to the packaging.
- Unpacking.
 - To check the contents the packaging must be removed.
 -  Complete the unpacking according to the «Unpacking» procedure of the supplied document together with this manual and/or attached to the CD/Pendrive.
- Contents.
 - Standard equipment up to 20 kVA (LV) / 40 kVA (HV): Documentation CD/Pendrive and battery fuses.
 - Standard equipment > 20 kVA (LV) / 40 kVA (HV) or type B1: Documentation CD/Pendrive.
 - Equipment 0 /: Documentation CD/Pendrive, wires and

needed supports to fit the batteries in, hardcopy circuit diagram and battery fuses (equipments up to 20 kVA (LV) / 40 kVA (HV) only).

- Battery cabinet: Fuses and cable connection bundle of 3,5 m. length and suitable cross section.
 - If the UPS belongs to a parallel system: A communication BUS bundle per equipment.
 - Once the reception is finished, it is advisable to pack the UPS again till its commissioning in order to protect it against mechanical impacts, dust, dirt, etc.
 - The packaging of the equipment has a cardboard pallet or wooden type depending on the case, expanded polystyrene corners, bag and polyethylene strip, all of them are recyclable materials. When it is required to dispose them, do it in accordance to the regulation in force.
- It is advisable to keep the packaging for 1 year as minimum.

5.1.2. Storage.

- The storage of the equipment, will be done in a dry and cool place, and protected from rain, dust, water jets or chemical agents. It is advisable to keep each equipment and battery set, inside their original packaging because they have been designed to assure the maximum protection during transport and storage.

Data label corresponding to the mod

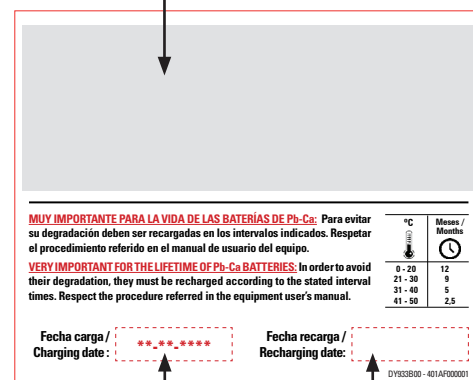

Charging date written down by the factory.
Space to write down the new recharge date.

Fig. 29. Label stucked in the packaging.

-  In general and less some particular cases, the UPS has sealed lead-acid batteries. In order to avoid its deterioration during the storage, they must be recharged in the stated period of time according to the temperature that they are exposed (see last charge written down in the labelling stucked in the equipment packaging or in the battery module, see Fig. 29).
- Lapsed this period of time, connect the equipment to mains together with the battery set if any, paying attention to the safety instructions and connection.
 - Models with separate static bypass line, is not needed to connect this power terminal strip.
 - Proceed to start it up as it is described in section 6, do not

turn «On» the output switch **(Q2)**, and do not start up the inverter through the control panel **(PC)**.

Leave the equipment in this mode for 12 hours as minimum.

- ❑ Once the battery recharging is finished, proceed to shut-down the equipment, disconnect it electrically and store the UPS and batteries if any, inside their original packaging, by writing down the new data of battery recharge into the label box (see Fig. 29).
- ❑ Regarding the battery recharge, units that belong to a parallel system will be treated as single equipments, so it is not needed any additional connection.

Do not store the equipments and/or battery modules, in places where either temperatures exceed over the stated ones in the technical specifications of section «9. Annexes» or indications in section «2.2.3.3. Safety warning regarding batteries» are not respected.

5.1.3. Transport until its location.

- UPSs up to 60 kVA (LV) / 120 kVA (HV) have casters, in order to make easier their transport until their location, where the two front casters are swivel and the rear ones are fix.

In the same way the battery cabinet has casters with identical structure, but in the smallest size of battery cabinet only.

For the rest of the models will be needed the use of a pallet jack or fork lift.

In any case pay attention to the weights stated in section «9. Annexes», in order to use the suitable mediums of transport for the weight of the equipment (pallet jack, fork lift, service lift or lift,...), as well as the features of the location (type of floor, resistance of the floor kg/m²,...).

5.1.4. Location, immobilised and considerations.

5.1.4.1. Location for single equipments.

- As i.e. Fig. 30 shows two typical cases depending on the model. The one that is based on a single cabinet, UPS with batteries fitted in, and the one of the UPS with batteries in a separate cabinet or extended back up time.

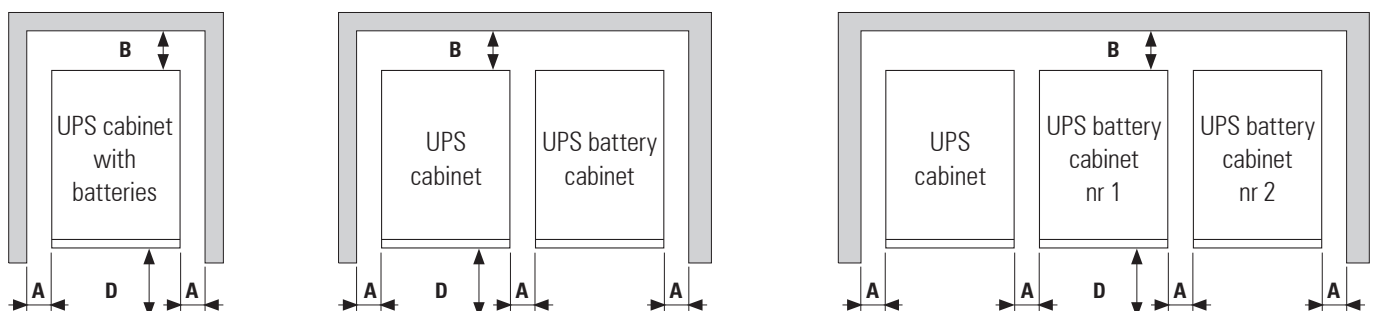

Fig. 30. Minimum peripheral dimension lines for UPS cooling.

- ❑ For cooling the unit, at least leave the free space stated in the table of document EK266*08 (Safety instructions).
- ❑ It is recommended to leave an additional 75 cm free at both sides, for the possible interventions of the **(T.S.S.)**, or the needed length of the connection wires to make easier its movement towards.

For extended back up times with more than one cabinet, it is recommended to put one at each side of the equipment and in case of having more cabinets repeat the same sequence alternately.

5.1.4.2. Location for parallel systems.

- As i.e. Fig. 31 shows 4 equipments in parallel with their respective battery cabinet. For systems with less units act in each case accordingly.
- It is advisable to put them in order by the Nr stated in the door of each equipment. The number corresponds to the assigned address preset from factory.

The arrangement is not random, because the length of battery wires (3,5 m.) and communication BUS (5 m.), this is the best one. For a higher quantity of battery cabinets in systems with extended back up time, follow the same criteria keeping the symmetry.

- When the system is structured by models with batteries and power electronics in the same cabinet, forget the battery modules illustrations.

❑ In order to have a correct cooling of the equipment, leave the surrounding space free of obstacles. Respect the minimum distances stated in the table of section 1.2.1 from EK266*08 (Safety instructions), where the figures, depending on the power rate of each equipment, for the A, B, C and D dimension lines are stated.

For battery cabinets, keep the same distances as for the UPS that makes the system.

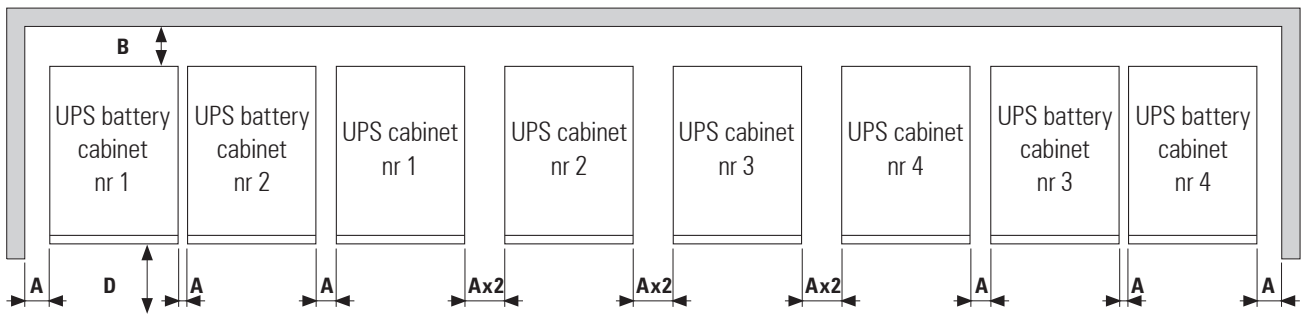

Fig. 31. Minimum peripheral dimension lines for system cooling.

5.1.4.3. Equipment immobilized and levelled.

- **UPS** from **SLC CUBE3+** series has casters (**RD**) and leveller feet (**PB**), less those equipments assembled in the two bigger size cabinets. These parts are also available in the smallest battery cabinet size.
- The purpose of the leveller feet (**PB**) is to immobilize and level the metallic enclosure, once it is located. Also, for those battery cabinets with sliding shelves give better stability and safety to the equipment.



Warning! Turnover danger when extracting the battery shelves without stabilising the unit previously. Do not extract more than one shelf at the same time, high risk of causing serious injuries to the operators due to the impact of the possible fall and/or trapping of the equipment.

- Loosen the elements (**PB**) by hand turning them counter-clockwise as far it would go with the floor and with the help of a spanner, loosen them half turn more in order to immobilize the metallic cabinet, having a correct levelling.

Fig. 32 shows how the stabilizers elements (**PB**) have to be finally.

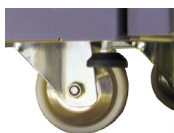

Original position from factory of the element (**PB**).



Element (**PB**) tighten against the floor.

Fig. 32. Equipment / battery module stabilisers elements (**PB**).

- Maintenance tasks of the equipment and batteries is completely reserved for **T.S.S.** or authorised personnel.
To have access to the batteries, both side covers from the cabinet must be removed. Those models and battery cabinets built in the smallest cabinet there are sliding shelves. Therefore, before doing any handling, pay attention to the indications stated in the label-

ling stuck to each one of them (see Fig. 32). The sliding shelves can only be removed the half per each side, on condition that the limits has been removed previously.

5.1.4.4. Preliminary considerations before connecting.

- The description of this manual refers to the connection of terminals and switching manoeuvring that are only available in some versions or equipments with extended back up time. Ignore those operations regarding them, if the unit does not have them.
- Follow and respect the instructions described in this section referred to the installation of a single equipment or parallel system.
- Switchgear or external manual bypass panel boards:
 - It is advisable to have an external manual bypass panel board equipped with input, output, static bypass (**CUBE3+ B** version only) and manual bypass protections, in single installations.
 - For parallel systems up to two units it is very **is very advisable** having a switchgear panel board and for systems with 3 or 4 equipments, **it is essential**. Switches of the panel board have to allow isolating the UPS from the system against any wrong operating and feed the loads with the rest ones, either during the preventive maintenance period or the reparation of itself.
- Under request an external manual bypass panel board for a single equipment or parallel system can be supplied.
Also it can be manufactured by yourself, paying attention to the version and setting of the available equipment or system and the attached documentation in the CD/Pendrive relating to «Recommended installation».
-  The «Recommended installation» information for each input and output setting is available with the supplied documentation, manual and/or CD/Pendrive. In that information is shown the circuit diagram, as well as the protection size and minimum cross section of the wires that are connected to the equipment, taking into account the nominal operating voltage. All figures are calculated for a **maximum total cable length of 30 m** between the distribution panel board, equipment and loads.
 - For longer lengths correct the cross sections accordingly, in order to avoid dropping voltages, by respecting the Regulations or norms corresponding to the country.
 - In the own documentation and for each setting, it is available the information for «N» units in parallel, as well as the features

of the own «Backfeed protection».

Power (kVA) for voltage LV/HV	HEXAGONAL SCREW METRIC OF THE TERMINAL / MAXIMUM Ø OF THE TERMINAL TO INSTALL ON THE CONNECTION TERMINAL (mm)																							
	Versión																							
	III/III				III/II (N)				II/III (M)				II/II (L)											
	Input	Output	Bypass (only in -B version)	Batteries	Input	Output	Bypass (only in -B version)	Batteries	Input	Output	Bypass (only in -B version)	Batteries	Input	Output	Bypass (only in -B version)	Batteries								
- / 7.5	M6 / 16	M6 / 16	M6 / 16	M6 / 16	M6 / 16	M8 / 22	M8 / 22	M6 / 16	M8 / 22	M6 / 16	M6 / 16	M6 / 16	M8 / 22	M8 / 22	M8 / 22	M6 / 16								
5/10	M6 / 16	M6 / 16	M6 / 16	M6 / 16	M6 / 16	M8 / 22	M8 / 22	M6 / 16	M8 / 22	M6 / 16	M6 / 16	M6 / 16	M8 / 22	M8 / 22	M8 / 22	M6 / 16								
7.5/15	M6 / 16	M6 / 16	M6 / 16	M6 / 16	M6 / 16	M8 / 22	M8 / 22	M6 / 16	M8 / 22	M6 / 16	M6 / 16	M6 / 16	M8 / 22	M8 / 22	M8 / 22	M6 / 16								
10/20	M6 / 16	M6 / 16	M6 / 16	M6 / 16	M6 / 16	M10 / 30	M10 / 30	M6 / 16	M10 / 30	M6 / 16	M6 / 16	M6 / 16	M10 / 30	M10 / 30	M10 / 30	M6 / 16								
15/30	M6 / 16	M6 / 16	M6 / 16	M6 / 16	M6 / 16	M10 / 30	M10 / 30	M6 / 16	M10 / 30	M6 / 16	M6 / 16	M6 / 16	M10 / 30	M10 / 30	M10 / 30	M6 / 16								
20/40	M6 / 16	M6 / 16	M6 / 16	M6 / 16	M6 / 16	M10 / 30	M10 / 30	M6 / 16	M10 / 30	M6 / 16	M6 / 16	M6 / 16	M10 / 30	M10 / 30	M10 / 30	M6 / 16								
- / 50	M8 / 22	M8 / 22	M8 / 22	M8 / 22	M8 / 22	M10 / 37	M10 / 37	M8 / 22	M10 / 37	M8 / 22	M8 / 22	M8 / 22	M10 / 37	M10 / 37	M10 / 37	M8 / 22								
30/60	M8 / 22	M8 / 22	M8 / 22	M8 / 22	M8 / 22	M10 / 37	M10 / 37	M8 / 22	M10 / 37	⁽⁶⁾ 35mm ²	⁽⁶⁾ 35mm ²	M8 / 22	M10 / 37	M10 / 37	M10 / 37	M8 / 22								
40/80	M8 / 24	M8 / 24	M8 / 24	M8 / 24	<table border="1"> <thead> <tr> <th>Screw metric</th> <th>Tightening torque (N-m)</th> </tr> </thead> <tbody> <tr> <td>M6</td> <td>2,5</td> </tr> <tr> <td>M8</td> <td>6,0</td> </tr> <tr> <td>M10</td> <td>10,0</td> </tr> </tbody> </table>												Screw metric	Tightening torque (N-m)	M6	2,5	M8	6,0	M10	10,0
Screw metric	Tightening torque (N-m)																							
M6	2,5																							
M8	6,0																							
M10	10,0																							
50/100	M10 / 30	M10 / 30	M10 / 30	M10 / 30																				
60/120	M10 / 30	M10 / 30	M10 / 30	M10 / 30																				
80/160	M10 / ⁽⁵⁾	M10 / ⁽⁵⁾	M10 / ⁽⁵⁾	M10 / ⁽⁵⁾																				
100/200	M10 / ⁽⁵⁾	M10 / ⁽⁵⁾	M10 / ⁽⁵⁾	M10 / ⁽⁵⁾																				

 ⁽⁵⁾ Connection of the cables over the own copper rods of the switches.

⁽⁶⁾ Terminal for ferrules of 35 mm².

Table 2. Screw metric of the equipment terminals, maximum Ø of the terminal to fit in and tightening torque.

- The information regarding the terminals of the equipment of each configuration and power rate is detailed in table 2 (screw metric, tightening torque, maximum diameter of the wire permissible by the terminals).
-  In parallel systems, the length and cross section of the wires that goes from the panel board to the each UPS and vice versa, will have the same for all of them, without any exception.
- Always take into account the cross cable section, as regards to the size of the own terminals of the switches, in order to embrace all their section properly for an optimal contact between both elements.
- In the nameplate of the equipment, nominal currents are only printed as it states the EN-IEC 62040-1 safety standard. The input current calculation, has been done taking into account the power factor and the own efficiency of the equipment.
- If other peripheral elements are added to the UPS or parallel system input, output or bypass like transformers or autotransformers, take into account the currents stated in the own nameplates of those elements in order to use the suitable cross sections, always respecting the Local and/or National Low Voltage Electrotechnical Regulations.
- When a UPS or parallel system include a galvanic isolation transformer, as standard, option or installed by yourself, either at the input line, bypass line, output or in all of them, protections against indirect contact (RCD) have to be fitted in at the output of each transformer, because in case of electrical shock in the secondary winding (output of the isolation transformer), its isolating feature will block the tripping of the protections located in the primary winding.
- As a reminder, all isolation transformer installed or supplied from factory, has the output neutral connected to earth by means of a bridge that connects the neutral and earth terminals. In case, an

isolated neutral were required, remove this bridge, by taking the precautionary measures stated in the respective local and/or national low voltage regulations.

- To enter the cables inside the cabinet, there are either cable glands (**PR**) assembled in the metallic structure or an only one opening as a register mode.
 - Models with power rate higher than 40 kVA (LV) / 80 kVA (HV), have a rod to fix the connection wires of the equipment to it, by means of clamps (**BF**).
- Once the cables are connected to their respective terminals, proceed to fix them by means of clamps to the rod (**BF**).
- In case of installing the equipment in IT neutral regime, the switches and circuit breaker protections must break the NEUTRAL as well as the three phases .

5.1.4.5. Preliminary considerations before connecting, as regards to batteries and protections.



- Inside the battery cabinet there are accessible parts with HAZARDOUS VOLTAGES, so electrical shock risk exists, therefore it is classified as RESTRICTED ACCESS AREA. This is why the key of the battery cabinet will not be available to the OPERATOR or END USER, unless he has been trained properly.
- At least, battery protection is always done by fuses and their physical layout depends on the battery location. Next, the different groups are described:
 - Models up to 20 kVA (LV) / 40 kVA (HV) with «standard» back up time. Batteries are supplied fitted in the same equipment cabinet. Also, for each one of the power rates, the standard back up time in the «0/» and «/» versions, leaves the needed space for the batteries in the same cabinet of the equipment.

- b. As a variant of group «a», there are models up to 20 kVA (LV) / 40 kVA (HV) with extended back up time, which are split in two subgroups:
 1. Batteries fitted in or ready to be fitted in part inside the own UPS cabinet and the rest in other cabinet/s or racks.
 2. All the batteries fitted in or ready to be fitted in other cabinet/s or racks.
 - c. Models with higher power rates than 20 kVA (LV) / 40 kVA (HV) and standard back up time, batteries are supplied in a separate cabinet and for extended back uptimes in one or more than one cabinets depending on the requested back up time.
Also for each one of the power rates, their standard back up times configuration in «0/» and «/» versions, have the battery installation in a separate cabinet from the equipment and for extended back up times in one or more than one cabinets, depending on the requested back up time.
- As a result of the battery layout, the respective protection will be placed as follows:
 - Equipments from group «a» stated as above.
Battery fuse holder with 3 fuses in the equipment, labelled in the figures and instructions of the present document as **(Q3)**.
 - Equipments from group «b.1.»
 - Battery fuse holder with 3 fuses in the equipment and in each battery cabinet. Labelled in the figures and instructions of the present document as **(F3)** and **(Q8)** respectively.
 - Battery switch added to the one of the equipment. Labelled in the figures and instructions of the present document as **(Q3)**.
 - Equipments from group «b.2.»
 - Battery switch in the equipment. Labelled in the figures and instructions of the present document as **(Q3)**.
 - Battery fuse holder with 3 fuses in the battery cabinet. Labelled in the figures and instructions of the present document as **(Q8)**.
For extended back up times with more than one battery cabinet, each one of them will have their own protection respectively **(Q8)**.
 - Equipments from group «c».
 - Battery switch in the equipment. Labelled in the figures and instructions of the present document as **(Q3)**.
 - Battery fuse holder with 3 fuses in each battery cabinet. Labelled in the figures and instructions of the present document as **(Q8)**.
To highlight that in the biggest battery cabinet with size Nr 3 and unlike the other two (Nr 1 and Nr 2), the user does not manoeuvre over the fuse holder switch, but over the switch labelled as **(Q8)**. Nevertheless, inside there are three protection fuses (not switchable) and labelled in the figures as **(F8)**.
 - Regarding the fuses, they are supplied in a plastic bag together with the equipment documentation and/or inside the battery cabinet, less for the battery cabinets for models higher than 60 kVA (LV) / 120 kVA (HV), which are joined to the cabinet mechanically.

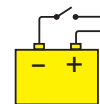
- The original type of the battery circuit, preset from factory is opened.



Put the fuses in the corresponding fuse holder switch and turn it «On» when it is indicated only, never before. To operate in other way, can cause irreversible damages to the equipment or serious and/or very serious injuries to the fitter, as he has been exposed to a possible electrical discharge during the connection of the UPS with the battery set or battery cabinet.

-  Do not manoeuvre the battery fuse holder switch and/or switch, when the equipment is turned on. This mechanisms **cannot be turned on/off with load**.
-  When power supply to the equipment or parallel system is broken beyond of a simple intervention and it is planned to have them out of service for long time, proceed to shut them down completely and remove the 3 fuses from the fuse holder switch or battery module for higher safety, and keep them in a safe place. For models higher than 60 kVA (LV) / 120 kVA (HV), open the battery switch in both cabinets (equipment and battery module).

5.1.4.6. Access to inside the cabinet for its connection.

- Any equipment and battery cabinet from **SLC CUBE3+** series has terminals as connection elements for the power. Also UPSs have a terminal strip for the auxiliary connections and HDB9 / DB9 communication connectors.

To have access to them proceed as follows and repeat the same procedure in each unit for parallel systems:

- Unblock the lock/s **(CL)** by means of the key **(LL)** supplied with the equipment, turn it to clockwise 45°.
- Open the front door **(PF)** completely. The connectors of communication ports and terminals for EPO remote button are visible.
- Remove the screws **(t1)** that fix the terminal cover **(TB)** to the cabinet and remove it; connection terminals are visible.
- When finishing the UPS connection, put the cover **(TB)** back, fix it with the screws **(t1)**, close the door **(PF)** with the key **(LL)** and lock **(CL)**.

Take into account the cross cable section, as regards to the size of the own terminals of the switches, in order to embrace all their section properly for an optimal contact between both elements.

5.2. CONNECTION.

- ⚠ This equipment is suitable to be installed in mains with power distribution system of TT, TN-S, TN-C or IT, taking into account when installing the particularities of the used system and the national electrical regulation of the destination country.
- For any information regarding the connection terminals of the equipment, check table 2.

5.2.1. Connection to mains, terminals (X1 to X4).

- ⚠ As this is an equipment with class I protection against electrical shocks, it is essential to install the protection earth conductor (connect earth (⊕)). Connect this conductor to terminal (X5), before supplying voltage to the input terminals.
- Equipments without static Bypass line, in accordance with the safety standard EN-IEC 62040-1, installation has to be provided with a «Backfeed protection» system, as for example a contactor, which will prevent the appearance of dangerous voltage or energy in the UPS input mains during a mains fault.
The standard is applicable both if power supply is single phase or three phase and for single units, and for each UPS of the parallel system.
 - ⓘ The «Recommended installation» information for each input and output setting is available with the supplied documentation, manual and/or CD/Pendrive. In that information is shown the circuit diagram, as well as the protection size and minimum cross section of the wires that are connected to the equipment, taking into account the nominal operating voltage. All figures are calculated for a **maximum total cable length of 30 m** between the distribution panel board, equipment and loads.
 - ☐ For longer lengths correct the cross sections accordingly, in order to avoid dropping voltages, by respecting the Regulations or norms corresponding to the country.
 - ☐ In the own documentation and for each setting, it is available the information for «N» units in parallel, as well as the features of the own «Backfeed protection».
- ⚠ There can be no derivation in the line that goes from the «Backfeed protection» to the UPS, as the safety standard would be infringed.
- Warning labels should be placed on all primary power switches installed in locations away from the equipment to alert the electrical maintenance staff of the presence of a UPS in the circuit. The label will bear the following or an equivalent text:

Before working on this circuit.

- ☐ Isolate the Uninterruptible Power System (UPS).
- ☐ Check the voltage between all terminals, including the protective earth.



Risk of UPS backfeed voltage.

- Connect the input cables to the respective terminals according to the available equipment setting.

For parallel systems, it will be necessary to repeat the connections that go from panel board to each equipment.

Connection to three phase mains:

Connect the power supply cables R-S-T-N to the input terminals (X1), (X2), (X3) and (X4), **respecting the phase rotation and neutral** indicated on the label of the equipment and in this manual. If the phase rotation is not respected, the equipment will not operate.

In case of discrepancies between the labelling and the instructions of this manual, the label will always prevail.

Connection to single phase mains:

Connect the power supply cables R-N to the input terminals (X1) and (X4), **respecting the order of phase and neutral** indicated on the label of the equipment and in this manual. If the order of the phase and neutral is not respected, the equipment will be damaged seriously.

In case of discrepancies between the labelling and the instructions of this manual, the label will always prevail.

5.2.2. Connection of separate static bypass line, terminals (X14 a X17). CUBE3+ B version only.

- ⚠ As this is an equipment with class I protection against electrical shocks, it is essential to install the protection earth conductor (connect earth (⊕)). Connect this conductor to terminal (X5), before supplying voltage to the input terminals.
- Equipments with static Bypass line, in accordance with the safety standard EN-IEC 62040-1, installation has to be provided with a «Backfeed protection» system, as for example a contactor, which will prevent the appearance of dangerous voltage or energy in the UPS input mains during a mains fault.
The standard is applicable both if power supply is single phase or three phase and for single units, and for each UPS of the parallel system.
 - ⓘ The «Recommended installation» information for each input and output setting is available with the supplied documentation, manual and/or CD/Pendrive. In that information is shown the circuit diagram, as well as the protection size and minimum cross section of the wires that are connected to the equipment, taking into account the nominal operating voltage. All figures are calculated for a **maximum total cable length of 30 m** between the distribution panel board, equipment and loads.
 - ☐ For longer lengths correct the cross sections accordingly, in order to avoid dropping voltages, by respecting the Regulations or norms corresponding to the country.
 - ☐ In the own documentation and for each setting, it is available the information for «N» units in parallel, as well as the features of the own «Backfeed protection».
- ⚠ There can be no derivation in the line that goes from the «Backfeed protection» to the UPS, as the safety standard would be infringed.
- Warning labels should be placed on all primary power switches installed in places away from the equipment to alert the electrical maintenance staff of the presence of a UPS in the circuit.

The label will bear the following or an equivalent text:

Before working on this circuit.

- Isolate the Uninterruptible Power System (UPS).
- Check the voltage between all terminals, including the protective earth.



Risk of UPS backfeed voltage.

- Connect the bypass input cables to the respective terminals according to the available equipment setting.

For parallel systems, it will be needed to repeat the connections that go from panel board to each equipment.

Connection to three phase bypass mains:

Connect the power supply cables R-S-T-N to the bypass terminals **(X14), (X15), (X16)** and **(X17)**, **respecting the phase rotation and neutral** indicated on the label of the equipment and in this manual. If the phase rotation is not respected, the equipment will not operate.



In case of discrepancies between the labelling and the instructions of this manual, the label will always prevail.

Connection to single phase bypass mains:

Connect the power supply cables R-N to the bypass terminals **(X14)** and **(X17)**, **respecting the order of phase and neutral** indicated on the label of the equipment and in this manual. If the order of the phase and neutral is not respected, the equipment will be damaged seriously.

In case of discrepancies between the labelling and the instructions of this manual, the label will always prevail.

5.2.3. Connection to the output, terminals (X6 to X9).

-  As this is an equipment with class I protection against electrical shocks, it is essential to install the protection earth conductor (connect earth (⊕)). Connect this conductor to terminal **(X5)**, before supplying voltage to the input terminals.
-  The «Recommended installation» information for each input and output setting is available with the supplied documentation, manual and/or CD/Pendrive. In that information is shown the circuit diagram, as well as the protection size and minimum cross section of the wires that are connected to the equipment, taking into account the nominal operating voltage. All figures are calculated for a **maximum total cable length of 30 m** between the distribution panel board, equipment and loads.
 - For longer lengths correct the cross sections accordingly, in order to avoid dropping voltages, by respecting the Regulations or norms corresponding to the country.
 - In the own documentation and for each setting, it is available the information for «N» units in parallel.
- Connect the output cables to the respective terminals according to the available equipment setting.

For parallel systems, it will be needed to repeat the connections that go from panel board to each equipment.

Connection to three phase output:

Connect the loads to U-V-W-N output terminals **(X6), (X7),**

(X8) and **(X9)**, **respecting the phase rotation and neutral** indicated on the label of the equipment and in this manual. If the phase rotation is not respected, the equipment will not operate.

In case of discrepancies between the labelling and the instructions of this manual, the label will always prevail.

Connection to single phase output:

Connect the loads to U-N output terminals **(X6)** and **(X9)**, **respecting the order of phase and neutral** indicated on the label of the equipment and in this manual. If the order of the phase and neutral is not respected, the equipment will be damaged seriously.

In case of discrepancies between the labelling and the instructions of this manual, the label will always prevail.

- With respect to the protection that must be placed on the output of the switchgear or manual bypass panel board, we recommend that the output power should be distributed in at least four lines. Each one should have a circuit breaker protection switch of the suitable value. This type of output power distribution will allow, in the event of a breakdown in any of the machines connected to the equipment that causes a short-circuit, will only affect to the line that is faulty. The rest of the connected loads will have their continuity assured due to the tripping of the protection of the line affected by the short-circuit only.

5.2.4. Connection to the battery terminals of the equipment (X11, X12 and X23), with the battery modules (X47, X48 and X49).

-  As this is an equipment with class I protection against electrical shocks, it is essential to install the protection earth conductor (connect earth (⊕)). Connect this conductor to terminal **(X5)**, before supplying voltage to the input terminals.
- The original type of the battery circuit, preset from factory is opened.

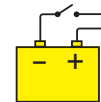

Put the fuses in the corresponding fuse holder switch and turn it «On» when it is indicated only, never before. To operate in other way, can cause irreversible damages to the equipment or serious and/or very serious injuries to the fitter, as he has been exposed to a possible electrical discharge during the connection of the UPS with the battery set or battery cabinet.

-  Do manoeuvre the battery fuse holder switch and/or switch, when the equipment is turned on. This mechanisms **cannot be turned on/off with load.**
- The connection of the battery cabinet with a UPS with power rate higher than 20 kVA (LV) / 40 kVA (HV) or for B1 models, will be done with the supplied cable bundle, by connecting one side to terminals **(X11), (X23), (X12)** and **(X19)** of UPS and the other one to terminals **(X47), (X49), (X48)** and **(X10)** of battery module, always respecting the stated polarity on the labelling of each element and this manual, as well as the colour of the cables (red for positive, black for negative, blue for middle tap (N) and green-yellow for earth bonding), see Fig. 33.
- For extended back up times with more than one battery module or cabinet, the connection will always be done in parallel among them and the equipment.

So, cable with black colour, from the UPS negative to the negative of the first battery cabinet and from this negative to the second battery cabinet and so on. Proceed in the same way, for connecting the positive red cable, the blue cable of the middle tap (N) and for the green-yellow of the earth bonding.

As an example Fig. 34 shows the connection between one UPS and two battery cabinets. Proceed in the same way when connecting more modules.

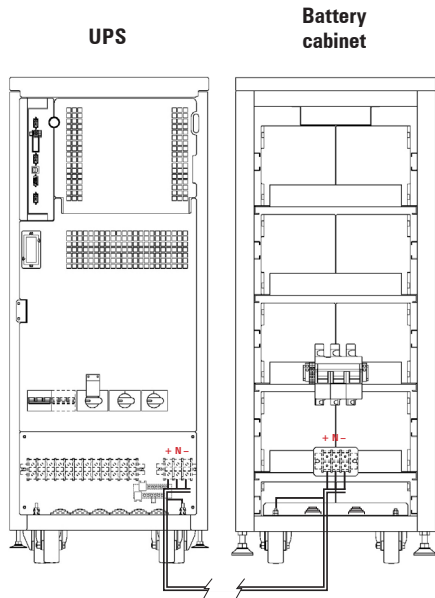

Fig. 33. Connection between UPS and battery cabinet.

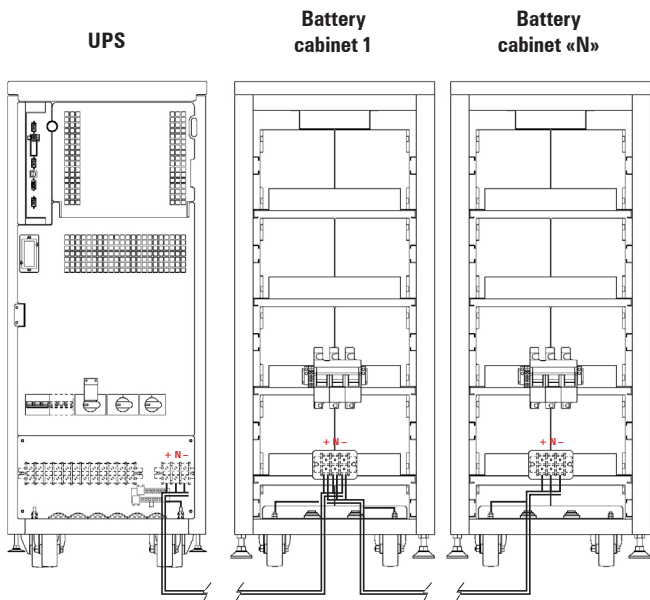

Fig. 34. Example of connection between UPS and two battery cabinets.

- In case of belonging or being connected to parallel system, the connection of the batteries with the UPS don not have any difference as regards to a single equipment, because by default, each battery set is connected directly with its UPS, regardless of the quantity of battery cabinets.

- Also, as an option, there is another structure, a common battery set for parallel system of two equipments fitted in a cabinet or rack. The connection of each UPS with the battery cabinet will be done with the supplied cable bundle, by connecting one side to terminals (X11), (X23), (X12) and (X10) of UPS and the other one to terminals (X47), (X49), (X48) and (X10) of battery module, always respecting the stated polarity on the labelling of each element and this manual, as well as the colour of the cables (red for positive, black for negative, blue for middle tap (N) and green-yellow for earth bonding), see Fig. 35.

Repeat the same procedure with the other UPS.

- This set can be extended in back up time and be based on several units connected in parallel among them and the own UPSs.
- **⚡ Electrical discharge danger.** If after starting up the UPS, it is required to disconnect the battery cabinet, the equipment has to be completely shutdown (see section 6.5). Turn off the battery fuse holder switch (Q8) located in the battery cabinet and/or fuse holder switch or switch (Q3) located in the UPS. Wait 5 min. at least till the filter capacitors have been discharged.

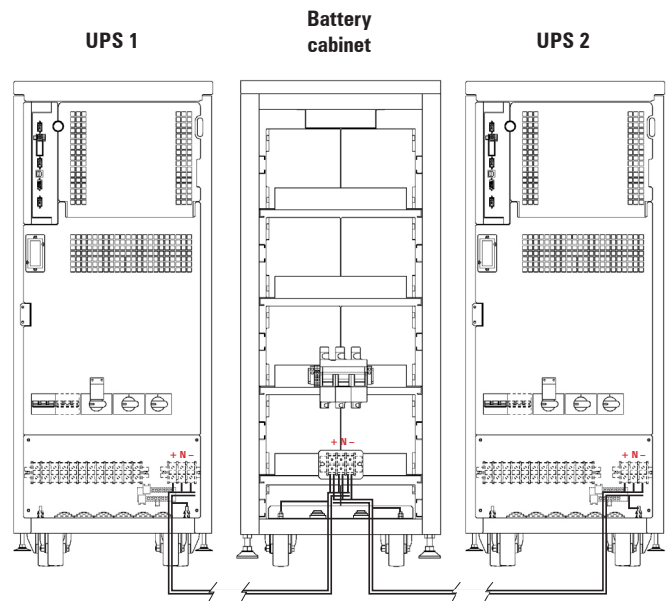



Fig. 35. Example of connection of two UPSs in parallel and a common battery set.

5.2.5. Connection to the input main protecting earth terminal (X5) and the earth bonding terminal (X10) .

- **⚡** As this is an equipment with class I protection against electrical shocks, it is essential to install the protection earth conductor (connect earth (⏚)). Connect this conductor to terminal (X5), before supplying voltage to the input terminals.
- The external battery cabinets will be connected to the bonding ground terminal (X10). The loads connected directly to the output terminals of the UPS will be connected to the bonding ground terminal (X10). The connection to the bonding ground (X10) will be prior to any other connection.
- All the terminals identified as bonding ground (⏚) are connected to the equipment ground.

5.2.6. Relay COM port. Connector (X32).

-  The communications line (COM) is a very low voltage circuit of safety and it must be installed separate from other lines that have dangerous voltages (power distribution line).
- The relay communication port provides digital signals in dry contacts form with a maximum applicable voltage and current of 2 A 30 V DC or 2 A 100 V AC. This channel makes possible the dialogue between the UPS and any other machines or devices, through the DB9 male connector **(X32)**.

Pin nr	Relay	Type of signal	Contact by default N.C.-N.O.
1		Shutdown signal +	-
2		Shutdown signal -	-
4	RL2	Discharge - Mains fault	N.C.
5	RL1 to RL4	Common	-
6	RL1	Equipment on Bypass	N.O.
7	RL3	Low battery	N.O.
8	RL4	General alarm	N.O.
9	RL2	Discharge - Mains fault	N.O.

- N.O. and N.C.: Normally opened and closed contact respectively.
- It changes its status, when the corresponding alarm is triggered.

Table 3. Relay interface alarm pin-out, DB9 connector **(X32)**.

- By default the equipment is supplied with 4 signal relays with a preset programming (see chart 3), which can be modified at factory or by teh **T.S.S.** under request. Chart 7 shows all the alarms that can be set to any relay.
Also, there is a «Shutdown» input that allows turning off the inverter, when there is a voltage between (5÷12 V) at this input.
- The most common use of these kinds of ports is to supply the necessary information to the file closing software.
- The base of front door **(PF)** has a slot to facilitate the entering and way out of the communication cables inside the UPS. Watch to not trap them between the door and cabinet when closing it.
- As an option the dry contacts can be supplied through a terminal strip, which will also have a fifth programmable relay as the 4 standard relays. The terminal strip is located in the communication card, for more information see EN062*01 document included in the CD/Pendrive.

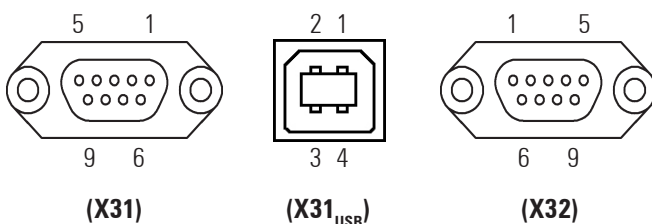



Fig. 36. DB9 connector **(X31)** and **(X32)**, and **(X31_{USB})**.

5.2.7. RS232/RS485 and USB COM 0 ports.

-  The communications line (COM) is a very low voltage circuit of safety and it must be installed separate from other lines that have dangerous voltages (power distribution line).

5.2.7.1. RS232/RS485 COM 0 ports. Connector (X31).

- In the same DB9 connector there are supplied both communication ports of the equipment, the RS232/RS485. Both ports cannot be used at the same time, because they are mutually exclusive.
- Both channels are used for connecting the UPS with any machine or devices that has this standard bus.
The RS232 consists of the transmission of serial data, so it is possible to send a large amount of information through a communication cable of just 3 wires.
- Physical structure of the RS232.
 - Pin 2. RXD. Serial data reception.
 - Pin 3. TXD. Serial data transmission.
 - Pin 5. GND. Ground signal.
- Physical structure of the RS485.

Unlike other serial communication links, this uses only 2 wires (pins 4 and 9 of the female DB9 connector) to make the dialogue among the systems connected to the network. The communication will be established by sending and receiving signals in differential mode, which gives the system great immunity to noise and a long range (approx. 800 m).

- Pin 4. Output signal A (+) of the RS485.
- Pin 9. Output signal B (-) of the RS485.
- Communication protocol.
The communication protocol used is «MASTER/SLAVE» type. The computer or computer system («MASTER») asks about a certain data, and the UPS («SLAVE») answers immediately with the required data.
If this communication way, is going to be used, ask for the protocol IN467*01.
Firstly the communication channel of the computer will be programmed with the same parameters as the communication channel of the UPS.
Then we will be ready to start the communication and therefore send to the UPS the first question.

If there is any problem meanwhile communicating, it will be advisable to repeat the initialization sequence of the channel.

- The communication parameters of the RS232/RS485 are:
 - Baud rate: 1200, 2400, 4800, 9600 or 19200 Bauds.
 - Nr of data bits: 8 Bits.
 - Nr of stop bits: 1 or 2 Bits.
 - Type of parity: Even, Odd or None.
- The base of front door **(PF)** has a slot to facilitate the entering and way out of the communication cables inside the UPS. Watch to not trap them between the door and cabinet when closing it.

5.2.7.2. COM or USB port. Connector (X31_{USB}).

- Basically is a RS232 communication through a physical connection of a USB connector. USB and DB9 of the RS232/RS485 can not be used simultaneously because they are mutually exclusive, with the USB as a priority.
- As well as the RS232/RS485 port, it is a serial data transmission and it is used to connect the UPS with any machine or device with USB connector.
- When connecting the UPS to an IT equipment, the driver installed in the IT device is started automatically, being able to establish the communication between both USB ports. Notice that this process takes its time, because it depends on different external factors (IT equipment, internet line,...).

In case the driver was not found in the IT equipment, go to the following website, and find the needed driver in section "VCP Drivers", download it and install it:

<http://www.ftdichip.com/>

- Physical structure of the USB port.
 - Pin 1. VCC. Isolated voltage +5 V.
 - Pin 2. D-. Data -.
 - Pin 3. D+. Data +.
 - Pin 4. GND. Ground signal.

- Communication protocol.

The used communication protocol is «MASTER/SLAVE» type. The computer or IT system («MASTER») asks about a particular data, and the UPS («SLAVE») answers with the required data.

In case this communication was required to connect an equipment, ask for the IN467*01 protocol.

Firstly, the communication channel of the computer has to set with the same parameters of the UPS communication channel.

Then, they will be ready to start the communication and therefore to send the first UPS question.

In case there was a problem in the communication, it is better to repeat the sequence of initialization of the channel.

- The communication parameters are:
 - Baud rate: 1200, 2400, 4800, 9600 or 19200 Bauds.
 - Information bits: 8 Bits.
 - Stop bits: 1 or 2 Bits.
 - Parity type: Even, Odd or None.

- The base of the front door (**PF**) has a slot to allow the entrance of the communication cables from outside to the UPS. Be careful to not trap them between the edges of the door and the cabinet, when closing it.

5.2.8. EPO terminals (X50).

- All UPSs have two terminals to install an external emergency button to shutdown the output (EPO).
- In case it was required to install a switch or button (EPO) in a single equipment, the cable bridge that closes the circuit has to be removed from terminal strip (**X50**) first.
- For a parallel system, two different solutions can be applied, which are the following:
 - Connect the button (EPO) in only one equipment of the parallel system.

Remove the cable bridge from terminals (**X50**) in the equipment that it is only connected.

In case of fault and removing of the equipment that has physically connected the button (EPO), there is the risk of leaving the system without the emergency stopping, unless it is reconnected to the other operative UPSs.

- Connect a button (EPO) to each equipment of the parallel system. To do that, remove all the cable bridges from terminals (**X50**) in each equipment.

Therefore, the functionality of the (EPO) will be kept in each one of them, regardless what occurs in the rest of equipments of the parallel system.

By means of the own communication BUS among the equipments that make the parallel system, any action over any button will affect to the whole.

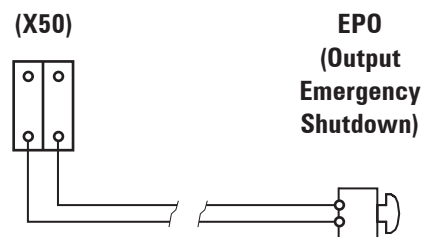

Fig. 37. Connection terminals for emergency shutdown switch or button (EPO), belonging to the end/user.

- In any case, the switch or button (EPO) has to be normally closed (NC), so the emergency shutdown order will be triggered when opening the circuit between these terminals (**X50**).



To restore the UPS to normal mode, invert the position of the switch or button (EPO), -close the circuit between the terminals (**X50**)-, unblock the button.

- To know the operating of (EPO), see section 6.6. of this manual.
- The base of front door (**PF**) has a slot to facilitate the entering and way out of the communication cables inside the UPS. Watch to not trap them between the door and cabinet when closing it.

5.2.9. Auxiliary contact and battery temperature probe terminal strip.

- All the equipments are provided with terminal strip that corresponds to the auxiliary contacts of manual bypass (**X51**) and output (**X45**) switches.
- Also in the equipments either with separate battery cabinet (models >20 kVA (LV) / >40 kVA (HV)) or in B1 equipments, the additional terminal strip (**X34**) are supplied, to connect the battery temperature probe that allows compensating the floating voltage according to the ambient temperature.
- Any wire connected to the terminals (**X34**), (**X45**) and (**X51**), will be entered into the equipment through the cable bushing (**PR**).

5.2.9.1. Terminal strip, auxiliary contact of manual bypass switch (X51).

- Terminal strip (X51) of two pins of the UPS, is connected in parallel with the normally opened auxiliary contact of the switch or manual bypass switch of the equipment.
- Switchgear panel board with manual bypass manufactured by us (option), there is a terminal strip of two terminals connected in parallel with the normally opened auxiliary contact of the switch or manual bypass switch of the own switchgear panel board. Any auxiliary contact of the manual bypass are moved on in advance when closing.
-  **In case of acquiring a switchgear panel board with manual bypass in another way, check that it has the stated auxiliary contact and connect it to the terminal strip (X51) of each equipment. As a must, the auxiliary contact has to be moved on in advance when closing.**
-  It is **ESSENTIAL** as safety measure of the system, loads included, to connect the terminal strips (X51) of the UPSs with the terminal strip with the same functionality of the switchgear panel board. **This way, any wrong action over any switch or manual bypass switch of the turned on UPSs will avoid causing a total or partial fault of the installation, loads included.**

5.2.9.2. Terminal strip, auxiliary contact of output switch (X45).

- This terminal strip of two pins is available in any equipment, but it is useful in parallel systems only.
- Basically, the normally opened auxiliary contact of the output switch, is extended till the terminal strip of two pins (X45). Through the isolated cable as a bridge mode that is supplied connected between both pins, the circuit is closed. Do not remove in single equipments, because although the equipment would be in operation, there would be an alarm of output switch deactivated.
- In those installations with parallel systems, the cable as a bridge mode connected between the two pins of the terminal strip (X45) of each UPS has to be removed, and connected to the terminals corresponding to the auxiliary contact of the output switch of the switchgear panel board.
-  **In case of acquiring a switchgear panel board by yourself, check that the output auxiliary contact is available and connect it to the terminal strip (X45) of each equipment. As a must, the auxiliary contact has to be moved on in advance when opening.**

5.2.9.3. Terminal strip, battery temperature probe (X34). For batteries in a separate cabinet only.

- As the battery manufacturer recommends a variable floating voltage depending on the ambient temperature.
The control of this feature will be done through the measurement of the temperature by means of a probe, located inside the cabinet itself when batteries and equipment are fitted in the same enclosure.
For those cases that batteries are supplied in a separate cabinet

out from the own UPS (models >20 kVA (LV) / >40 kVA (HV) or B1 equipments, there will be a terminal strip of two pins (X34), that allows bringing the probe located at the end of a two wires bundle with 4.5 m., till inside the battery cabinet.

The connection of the two wires from the cable bundle to the terminal strip (X34) does not have polarity.

- Also via this probe the ambient temperature inside the battery cabinet can be visualized in the control panel with LCD.
- The bundle with the probe will always be supplied already connected to the terminal strip (X34), so it is only necessary to cut the clamp that keep it rolled, to take it out from the UPS cabinet and enter it into the battery cabinet, in both cases, through the foreseen cable bushing (PR).

5.2.9.4. Ethernet connectors (X34_{ETH}) in the UPS and (X38_{ETH}) in the battery cabinet. For separate battery cabinets and probe bundle > 5 m, only.

- For those installations, where the distance between the UPS and batteries needs a temperature probe bundle higher than 5 m. length, the connector (X34) described in the previous section 5.2.9.3. cannot be used, so the connector (X34_{ETH}) will be used instead.

Although, regarding operation to compensate the floating voltage according to the ambient temperature, there is no difference, but the connection between cabinets needs the installation of the option electronic card in the battery cabinet. In this card, the (X38_{ETH}) connector has to be connected the communication channel bundle of 8 wires to its counterpart in the UPS (X34_{ETH}).

Use the cable glands (PR) included in the base of the both cabinets to pass the communication cable from inside to outside of the equipment, depending on the point of view.

At the same time the own temperature probe is connected to the optional electronic card and placed inside the battery cabinet.

5.2.10. Connection of parallel BUS (X36i) and (X36o).

- This section is only useful for parallel systems.
- For the correct operation of the parallel functions and operating, any unit connected in parallel are continuously communicated among them. It is achieved by means of the called communication line or BUS.
- Any operation of this section, regarding parallel systems, has to be done by authorised staff of our firm.
- Once the power connections of the UPSs of the parallel systems are done, it is needed to make the ones related to the control or communication BUS. To do it, connect them in a sequential way, two lines of the communication BUS between a unit and its adjacent.

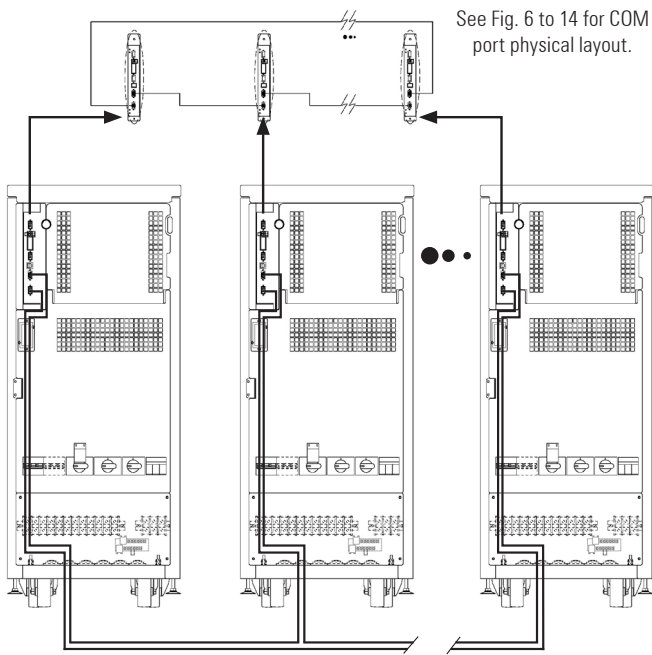

Fig. 38. Connection of the communication BUS.

- As an example, Fig. 38 shows, how the communication BUS connections have to be done.

Although this illustration is not representative for the complete **SLC CUBE3+** series, as for the format of the cabinet, terminal layout or size and/or switches, as well as the own communication ports, it expects to be a guide to clarify the possible doubts on how the communication loop has to be connected.

To see the physical layout of the COM connectors for each power rate, refer to the illustrations of figures 6 to 14.

- The base of front door (**PF**) has a slot to facilitate the entering and way out of the communication cables inside the UPS. Watch to not trap them between the door and cabinet when closing it.

- Together with each UPS of a parallel system, it is supplied a 15 wires bundle with HDB15 connectors at both ends, one male and the other one female, with a length of 5 m. Therefore, there will be as many communication BUS bundles (**BC**), as quantity of equipments to parallel have the system.

5.2.10.1. Connection of the communication or BUS bundle (BC).

- Respect the sequence and connection order of the communication BUS among correlative equipments.

Although the order of the connections of communication BUS among equipments are made, is not important, on condition that the communication loop is completed or closed properly, it is advisable to carry out the connections with the immediately next equipments in order simplify the connection.

- The connection limit of the installation, will be determined by the quantity of available equipments to parallel and in any case till a maximum of four units.
- Each equipment has two HDB15 connectors for the communications among them, one male labelled as "Output" (**X36_o**) and another one female as "Input" (**X36_i**).
- In the same way, all the bundles supplied with the equipments, are equal in connections and length.

⚠ DO NOT MODIFY THE COMMUNICATION BUS BUNDLE, OR THE CONNECTORS UNDER ANY CONCEPT.

- Take one of the bundles and insert the HDB15 female connector located in one of its ends, into the male connector labelled as "Output" (**X36_o**), in any of the equipments of the system and insert the HDB15 male connector located in the opposite end of the bundle into the female connector labelled as "Input" (**X36_i**) of the adjoining equipment.
- Repeat the previous step with each equipment of the system, till closing the communication BUS loop or ring.

6. OPERATING.

-  **In this section, it is described the procedure to commissioning and shutdown the equipment, nevertheless depending on the control panel included in the equipment, alphanumerical or touchscreen, the procedure will be different. Proceed according to the control panel built in the unit.**

For more information about the alphanumerical screen, consult section 7 and for touch screen consult the attached document EL064*01 in the CD/Pendrive.

- During the description of this section, it is detailed the procedure to follow to get the different functionality, considering a system of «n» equipments connected in parallel.

If in your case, it is available **only one** UPS from **SLC CUBE3+**, series, proceed in the same order, but simplifying the operating for a **single** unit.

-  As it has been stated before, it is advisable to have an external manual bypass panel board equipped with input, output, static bypass (**CUBE3+ B** version only) and manual bypass protections, in single installations.

For parallel systems, more than **recommended** it is considered **essential**, to have a protection panel.

- The switches from the panel allows both isolating each UPS of the system in a single way against any failure and feeding the loads with the rest of the equipments.
- Also, it is a safety precaution measures for the maintenance personnel of T.S.S., because it allows making the needed tasks with no risk of electrical shock.

- Therefore it has been considered appropriate and naturally, to contemplate in the instructions of the equipment, the operating of a system with «n» equipments connected in parallel with their respective external manual bypass panel board as it is shown in the «Recommended installation» documentation included in the CD/Pendrive.

This panel board allows isolating each equipment individually in case of fault and removing it without any difficulty for its repair or replacement. Also, the included manual bypass switch makes easier the preventive maintenance tasks or intervention over the complete system, supplying the voltage to the loads directly from mains, on the «bypass» mode operating, meanwhile the input voltage is available.

In those installations without the external manual bypass panel board, omit the actions and steps that involve the manoeuvring of their switches.

6.1. RELEVANT PRELIMINARY CONSIDERATIONS .

- It is very important to always operate in the established order in the described instructions in the next sections, by respecting the sequence of the switches in relation to its function.

So, i.e. in parallel system based on four equipments, when it is stated to turn on the «Input» mechanisms, the order of turning on them will not matter, but any other switch with different function as it could be «Output» switch will not be turned on, till is stated.

- Unlike other UPS structures, where the «Master» and «Slave» equipments are preset strictly from factory, conditioning the order of start up and shutdown, the new **SLC CUBE3+** series is managed by a more flexible hierarchy according to the operating mode that it is.

6.2. UPS OR SYSTEM START UP.

6.2.1. Controls before starting up.

- Make sure that all the connections have been made correctly and are sufficiently tight, respecting the labelling of the equipment and instructions of section «5.- Installation and connection of the unit»
- Check that the UPS or each UPS switches and the batteries cabinet or cabinets, as well as the switchgear panel board are turned (position «Off»).
- Be sure that all the loads are turned «Off».

6.2.2. Start up procedure.

6.2.2.1. First start up procedure.

- When commissioning an equipment for first time, the installation menu is automatically triggered in the control panel, by default it is displayed in «English» language. By means of this menu, the following parameters can be set: language, time and date, nominal operating voltage and frequency of the equipment.

Although depending on the UPS model, the control panel can be alphanumerical or touchscreen, the graphics can differ but the quantity of parameters to set are the same. In the first case, each one of them are selected and entered in separate menus through chained screens and in the second one, they are displayed through a single screen by means of drop down fields to select the several input figures.

-  For parallel systems, repeat the steps for each one of them that it makes up, being able to do it in all of them at the same time or chronologically one by one.
- Supply input voltage to the switchgear panel board.
- Turn «On» the input switch or switches of the panel board.
- Turn «On» the UPS input switch (**Q1a**) or from each equipment that the systems is make up.
- **In equipments with alphanumerical display**, the following message will be displayed for a few seconds:

CONFIGURATION
MENU

and the acoustic alarm will beep every 5 sec. Next the following message will be displayed in the LCD panel:

LANGUAGE
AAAAAA

... where AAAAAA corresponds to the language of the menus displayed in the LCD panel. The available languages are: English, Spanish, French, German, Turkish and Russian.

By means of the keys (▲) and (▼), move till selecting the language and validate with (ENT). Since this moment, the screens will be displayed in the set language (in this case English).

The screen to set the time (hour, minutes, seconds) and date (day of the week, day of the month, month and year) will be displayed.

Clock: HH:MM:SS
Date: WKD DD/MM/YYYY

To begin the time and date setting press (ENT). Each character that has a value, it is modified one by one, to change the first character of the field use the keys (▲) and (▼) and validate with (ENT). To jump to the next character use the keys (▶) and (◀). To finish press (ESC), the values will be validated and the following screen is displayed.

UNIT NOMINAL VOLTAGE
3 X AAA V

... where AAA corresponds to the nominal phase to phase value, of the operating voltage of the equipment.

- By means of the keys (▲) and (▼), move it till the nominal value of the power supply voltage and validate it with (ENT).
When the wished value is not in the chart 4, select the closest one and validate with (ENT).

Type of voltage interval	Value of phase to phase voltage
LV (Low voltage), Referred to the model	3x200 V / 3x208 V / 3x220 V / 3x230V
HV (High voltage)	3x380 V / 3x400 V / 3x415 V

Table 4. Nominal values, operating voltages of the equipment.

Once the operating voltage is selected, it is compulsory to select the nominal frequency. The following message is displayed:

NOMINAL FREQUENCY
AAAA

- By means of the keys (▲) and (▼), move till one of the following frequency values and validate with (ENT):
 - 50 Hz: Frequency of the equipment (rectifier and inverter), will be set to 50 Hz.
 - 60 Hz: Frequency of the unit (rectifier and inverter), will be set to 60 Hz.
 - AUTO: In each UPS start up, the input frequency will be sensed and set to 50 or 60 Hz accordingly.



This setting is not recommended if the unit is supplied by a generator set.

Once the working frequency has been selected, **and only for LV equipment (low voltage, "A" in the model reference)**, it is possible to choose the number of batteries, among the following options: 36 (18+18), 38 (19+19) y 40 (20+20). Choose the correct value using the keys (▲) and (▼), and confirm with (ENT).

BATTERY NUMBER
36 (18+18)

This configuration is indicated on the equipment label, or battery cabinet, see Fig. 39.

In HV (high voltage) equipment, the number of batteries is fixed, 62 (31+31) and, therefore, this configuration screen does not appear.

The next adjustment to make is the number of battery strings.

STRINGS NUMBER
1

On the battery configuration label (see Fig. 39), the number of battery strings (between 1 and 6) is also indicated. Enter this value in this configuration screen (modification using the keys (▲) and (▼), and confirm with (ENT)).

As the last battery configuration data, we must enter the capacity of each of the battery blocks that make up the string(s) (between 3.0Ah and 900.0Ah). Obtain the value to enter according to the label (see Fig. 39). Scroll through the digits with keys (▶) and (◀), modification with keys (▲) and (▼), and confirm with (ENT).

SINGLE BATT. BLOCK
CAPACITY: xxx.xAh

Once the operating frequency is selected, the following message will be displayed:

CONFIG. COMPLETED ?
<ENT> YES <ESC> NO

Press the (ENT) key to validate the values, the acoustic alarm will be stopped.

Press (ESC) to go back to the start of the installation menu to set them again.



Once they are validated, it will not be possible to set them again, being necessary the **T.S.S.** intervention.

- Omit the possible wrong rotation alarm triggering that could arise during the procedure over an equipment, because it will be treated in section 6.2.2.2.
- Continue with the described procedure in the next section, considering that the stated actions in the first three steps are already done.

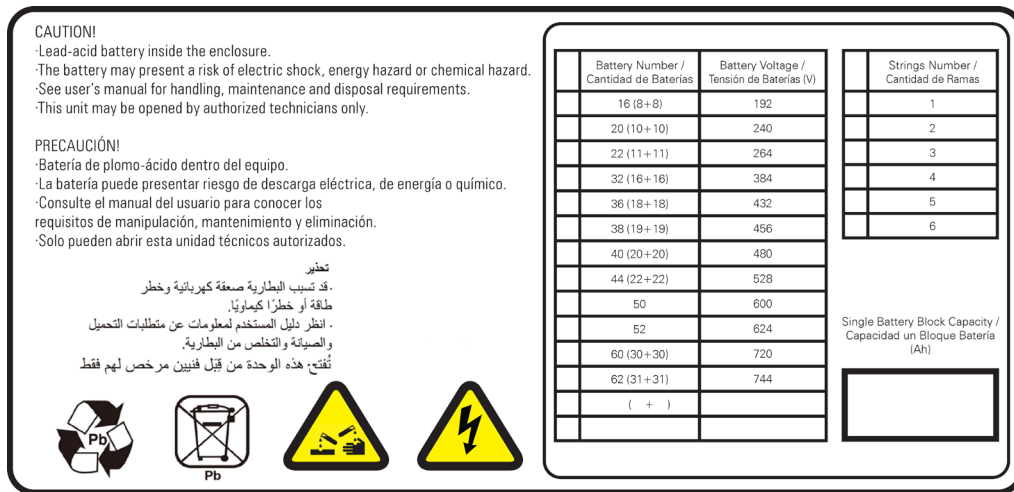

Fig. 39. Battery configuration label affixed to the equipment.

- **In equipments with touchscreen**, the installation menu will be displayed by means of 2 screens with all the parameters to select. Proceed according to section 1 of the ELO64*01 document.

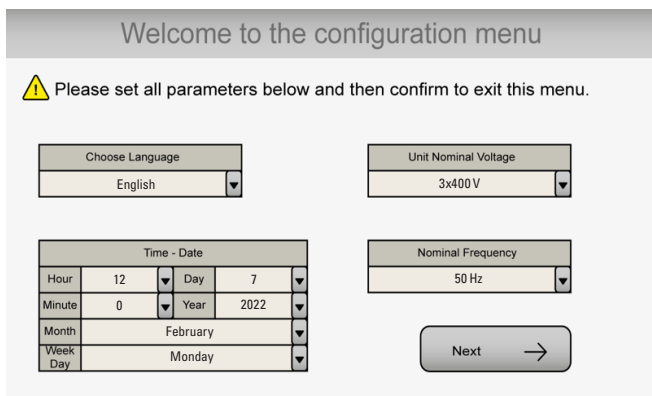

Fig. 40. First configuration screen.

⚠ If Spanish has been chosen on the language screen, this will be the default language that will appear on the rest of the screens. For the rest of the languages, the screen will appear in English by default until it is changed in the First configuration screen (Fig. 40).

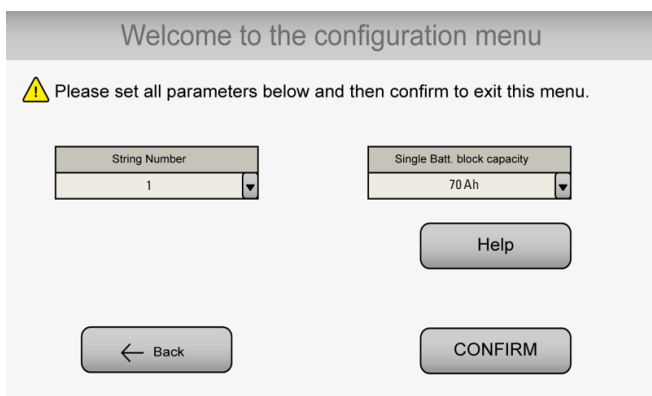

Fig. 41. Second HV equipment configuration screen.

In the case of LV equipment, this second screen changes:

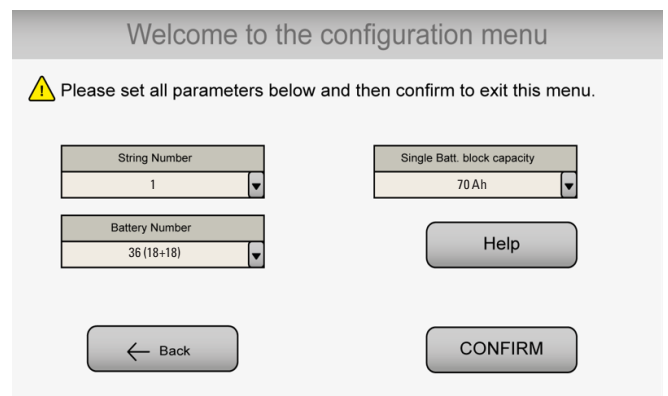

Fig. 42. Second LV equipment configuration screen.

6.2.2.2. Daily start up procedure, for equipments with alphanumerical display.

When coming from the previous section the first three steps will be skipped, because they are already done in the first commissioning. For the daily start up procedure, starting from equipment/s shutdown completely, make all the next stated actions:

- Supply input voltage to the switchgear panel board.
- Turn «On» the input switch or switches of the panel board, depending if it is a single equipment or parallel system.
- Turn the UPS or each UPS input switch (**Q1a**) to «On» position.
- The LCD of the Control Panel (**PC**) of each equipment will be turned on automatically.

For single equipments the LCD panel will display the left message of the screen 0.0 and for parallel systems both messages will be displayed 0.0 :



Where in parallel systems, the right screen 0.0 corresponds to:

- ❑ Paral. ---, address of each UPS with three characters, in the example is 002.
- ❑ Out.SW ---, the position of the output switch of the UPS and/or switchgear panel board, with two status ON and OFF (the auxiliary contact of the output switch in the output panel board has to be connected according to the instructions of section 5.2.9.2.).

- If the following alarm message appears on the LCD Control Panel ...



... also an audible alarm will beep in each equipment with the message in the screen and the affected UPS/s not be able to be started up, due to the wrong input phase rotation.

- ❑ If it happens in only one UPS of the parallel system, turn «Off» the input switch (**Q1a**) of the corresponding equipment and the one in the switchgear panel board. Swap two phases of the input terminals of the UPS leaving the connections in the same order as the rest of the equipments and repeat the start up procedure described up to now.
 - ❑ If it happens in all equipments of the parallel system, turn «Off» the input switch (**Q1a**) of each UPS and input switches of the switchgear panel board, swap two phases in the input terminals of the switchgear panel and repeat the start up procedure described up to now.
- In equipments or systems with separate static bypass line **SLC CUBE3+ B**:

Turn the bypass switches from panel board «On».
Turn the bypass switches (**Q4a**) of each UPS to «On».

- If the following alarm message appears on the LCD Control Panel ...



... also an audible alarm will beep in each equipment with the message in the screen and the affected UPS/s will not be able to be started up, due to the wrong bypass phase rotation.

- ❑ If it happens in only one UPS of the parallel system, turn «Off» the bypass switch (**Q4a**) of the corresponding equipment and the one in the switchgear panel board. Swap two phases of the bypass terminals of the UPS leaving the connections in the same order as the rest of the equipments and repeat the start up procedure described in the three previous steps.
 - ❑ If it happens in all equipments of the parallel system, turn «Off» the bypass switch (**Q4a**) of each UPS and bypass switches of the switchgear panel board, swap two phases in the bypass terminals of the switchgear panel and repeat the start up procedure described in the three previous steps up to now.
- At this point, with no active alarm, green LED of Input Voltage OK (**a**) (see Fig. 42), should light in all UPSs.
 - Start up the inverter, by means of the keypad (**3**) (see Fig. 42). In parallel systems make the procedure equipment by equipment the first time or after complete shutdown, in order to establish the communications among each unit of the system.

From main screen press (**▼**) key to access to «CONTROL AND STATUS OF THE UNIT» submenu (screen 1.0), and then press (**▶**) key. The screen 1.1 will be displayed, asking you to start the equipment up by pressing (**ENT**). Do so, and then validate the operation by pressing (**ENT**) again. See the diagram of Fig. 39.

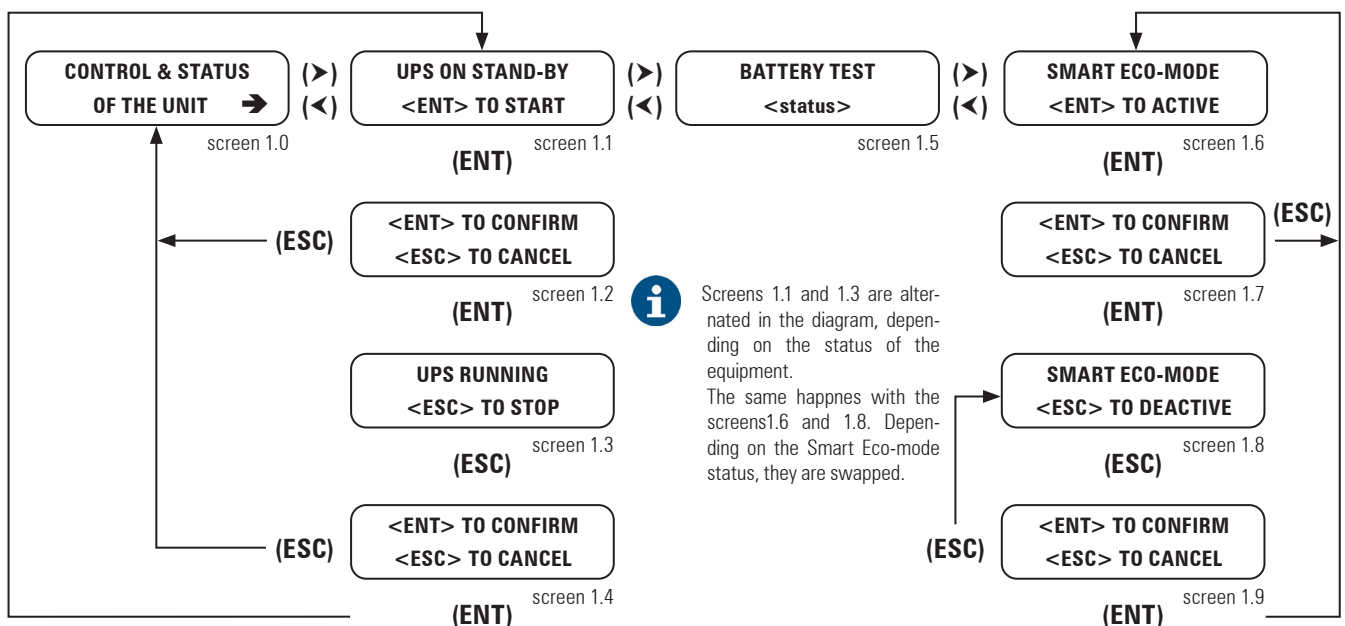

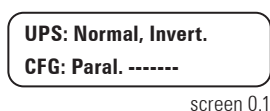

Fig. 43. Diagram, start up/shutdown procedure.

- After about 30 seconds, the inverter and rectifier of the UPS or each UPS will be running, but not supplying output voltage because their respective switches **(Q2)** of the equipment and panel board are still turned off.

In parallel systems, the first UPS starting the inverter will be the one set as «Paral. Mst. Byp», the one with the highest address as «Paral. Slv. By.Rsv» and the rest ones, if any as «Paral. Slv. By». Logically, in parallel systems of two UPS units there will not be any «Paral. Slv. By».

-  Parallel equipments only.
To check the hierarchy of the UPSs (parallel status), is needed to go back to main screen in each equipment (press 3 times **(ESC)**) and access to screen 0.1 in all of them (press once **(▶)** key), see Fig. 44:



Where:

- First row corresponds the UPS status.
- And the second to the UPS hierarchy relating to the rest of the system, which is dynamic depending on the status of the rest of the equipments:
 - «Paral. Mst. Byp» bypass Master of the parallel system. By default, the first UPS starting up the inverter according to the established procedure.
 - «Paral. Slv. By.Rsv» reserved bypass Slave. Initially corresponds to the equipment with the highest address excepting the one from «bypass Master». In case of failure of the Master, it will take its functions.
 - «Paral. Slv. Byp» bypass Slave of the parallel system (systems with more than two equipments only). It will become as «reserved bypass Slave», when it practise as «bypass Master». In systems with more than three equipments in parallel, the hierarchy of «reserved bypass Slave» will be taken by the one with the highest address among the «bypass Slave».
 - «Paral. Mst. Volt» voltage Master of the parallel system. By default, the first UPS on normal operating (inverter in operation), that the output switch **(Q2)** is turned «On».
 - «Paral. Slv. Vt.Rsv» reserved voltage Slave of the parallel system. Equipment on normal operating (inverter in operation), that the output switch **(Q2)** is turned «On» in 2nd place or subsequently (after the «Paral. Mst. Volt» or «Paral. Mst. Vt.Rsv»). Initially, it corresponds to the equipment with the highest address, excepting the one from «Voltage Master». In case of failure of the Master, it will take its functions.
 - «Paral. Slv. Volt» voltage Slave of the parallel system (systems with more than two equipments only). Equipment on normal operating (inverter in operation), that the output switch **(Q2)** is turned «On» in 2nd place or subsequently (after the «Paral. Mst. Volt» or «Paral. Mst. Vt.Rsv»). It will become as «reserved voltage Slave», when it practise as «voltage Master». In systems with more than three equipments in parallel, the hierarchy of «reserved voltage Slave» will be taken by the one with the highest address among the «voltage Slave».

- Turn «On» the output switch or switches of the panel board, depending if it is single equipment or parallel system.
- Turn the output switch **(Q2)** of the UPS or each UPS «On».

The equipment or parallel system supplies voltage to the output terminals of the switchgear panel board.

- Make sure that the inverter on LED indication **(c)** lights (green), and bypass LED **(b)** is turned OFF in all UPSs (see Fig. 42).

If the status of the LEDs is wrong, please contact with the **T.S.S.** (Technical Service & Support).

- For equipments with external battery cabinet, turn the switch-fuse holder of the battery cabinet or cabinets **(Q8)** of each UPS to position «On».

 **DO NOT TRY to make this manoeuvring at any other time and/or in other way, because this operating could damage the equipment and/or cause accidents.**

- Once the rectifier is completely working, a process of equalization (DC bus voltage starts to be equalized with battery voltage) will be started. After a few seconds (depending on the battery level), an alarm message like this will be displayed...



... it shows that the equalising process has been finished and **AT THIS MOMENT ONLY** is when the battery switch, the battery protection or both elements can be turned «On»:

- Equipments with a single battery mechanism, either the battery fuse holder switch or the battery switch and labelled in the figures of the present document as **(Q3)**. Turn it «On».
- Equipments with two battery mechanisms, fuse holder switch **(F3)** and switch **(Q3)**.

1. Turn the battery fuse holder switch **(F3)** «On» first.
2. Next, turn the battery switch **(Q3)** «On».

In parallel systems, repeat this process in each equipment.

 **DO NOT TRY to make this manoeuvring at any other time and/or in other way, because this operating could damage the equipment and/or cause accidents.**

- If the equipment or parallel system has an outgoing distribution, turn its switches «On».
- Start up the loads to be supplied in a progressive way. The joint is started up completely, and the loads are protected through the UPS or UPS parallel system.

-  After the first start up, the usual start up/shutdown operation of an equipment or parallel joint will be done by means of the keypad of the control panel **(PC)**. In parallel systems, will be needed to act over one of them only.

 Consider that the UPS or system will still be supplying output voltage, it does not matter the status of the own inverter or inverters:

- Shutdown, from static bypass.
- Started up, from inverter (On-line mode).
- Started up, from static bypass (on Smart ECO Mode).

6.2.2.3. Daily start up procedure, for equipments with touchscreen.

When coming from section 6.2.2.1, the first three steps will be skipped, because they have been already done in the first commissioning. For the daily start up procedure starting from equipment/s shutdown completely, make all the actions next stated:

- Feed input voltage to the protection panel.
- Turn the input switch or switches «On», depending if it is a single equipment or parallel system.
- Turn the input switch **(Q1a)** of the UPS or each UPS «On».
- The touch screen from control panel **(PC)** of each equipment will be triggered automatically.

A screen like the one shown next, as mere example, will be displayed, where depending on the typology of the input and output mains, single or three phase, the availability or not of the separate bypass line and depending on its status, the single line diagram will vary according to them, stating the voltage figures in each case.

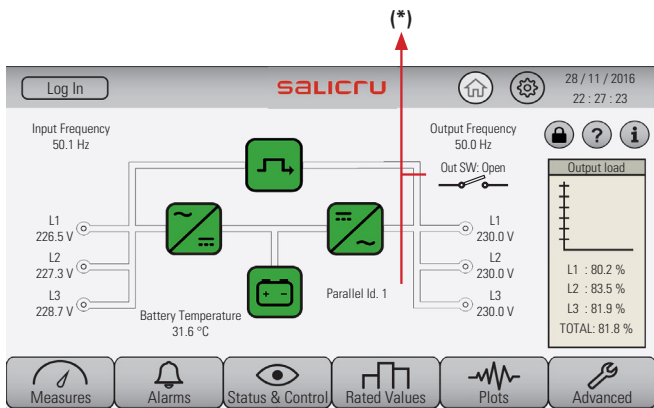

(*) Information represented in systems to operate in parallel only.

- Parallel Id. 1. It informs about the address of each UPS with one character. In the example is 1.
- Output switch: Opened. It informs about the position of the UPS and/or protection panel output switch, with two status «opened» or «closed» (it is compulsory to connect the auxiliary contact of the output switch of the panel according to the indications stated in section 5.2.9.2.).



Fig. 44. Example screen about the touchscreen panel **(PC)**.

- If during the start up procedure, the «Alarm» icon was ON in red colour in the lower row of main menu, check the cause, because if the phase rotation is wrong, the UPS will not be able to start up.
- Always together with any triggered alarm there will be an acoustic alarm of a single modulation and intensity.
- Proceed as follows:
 - Touch over the «Alarm» icon .
 - Check, if the «Phase rotation: UPS Start up disable» is displayed.
 - To acknowledge and silent any alarm, touch over the

«Alarm acknowledgement» icon .

- If this situation happens in a single UPS of the parallel system, turn the input switch **(Q1a)** of the equipment and the switch of the protection panel «Off». Swap two phases of the UPS input terminal strip and leave the rest one in the same order and repeat the start up procedure already described.
- If this situation happens in all the equipments of the parallel system, turn the input switch of each UPS **(Q1a)** and the input switches of the protection panel «Off». Swap two phases of the input protection panel and leave the rest one in the same order and repeat the start up procedure already described.
- In equipments or systems with separate bypass line **SLC CUBE3+ B**:
 - Turn the bypass switches of the panel to «On».
 - Turn the bypass switches of each UPS **(Q4a)** to «On».
 - If during the start up procedure, the «Alarm» icon was ON in red colour in the lower row of main menu, check the cause, because if the phase rotation is wrong, the UPS will not be able to start up.
 - Proceed as follows:
 - Touch over the «Alarm» icon .
 - Check, if the «Phase rotation: UPS Start up disable» is displayed.
 - If this situation happens in a single UPS of the parallel system, turn the bypass switch **(Q4a)** of the corresponding equipment and the switch of the protection panel «Off». Swap two phases of the UPS bypass terminal strip and leave the rest one in the same order and repeat the start up procedure already described in the three previous steps.
 - If this situation happens in all the equipments of the parallel system, turn the input switch of each UPS **(Q1a)** and the input switches of the protection panel «Off». Swap two phases of the input protection panel and leave the rest one in the same order and repeat the start up procedure already described
 - If this situation happens in all the equipments of the parallel system, turn the bypass switch of each UPS **(Q1a)** and the bypass switches of the protection panel «Off». Swap two phases of the bypass protection panel and leave the rest one in the same order and repeat the start up procedure already described in the three previous steps.
 - If everything is correct, the touch screen will display a graphic like Fig. 40, bridging the gap among the possible configurations different from III/III and/or separate bypass feature. In the EL064*01 document, other configurations are shown as mere examples too.
 - Start the inverter of the equipment/s up. To do it, proceed as follows:
 - Touch over the «Status and control» icon .
 - Touch over the «Start /Stop UPS» icon .
 - The following «Pop up» message will be displayed, asking to the end-user, if it you are sure . Confirm the action by touching over «YES».
- After 30 seconds, the inverter and rectifier of the UPS or each UPS will start up, but there will not be output voltage, because the switch **(Q2)** of the equipment or each equipment is/are not turned «on», even the panel ones too.

In parallel systems, the first UPS started up will be set as «Parallel Master Bypass», then the one that has the highest address as «Parallel Slave Bypass Reserve» and the rest ones, if any, as «Parallel Slave Bypass». Obviously, in parallel systems of two equipments there will not be «Parallel Slave Bypass».

-  To see the hierarchy of each UPS of the parallel system, proceed as follows:
 - Press over the  icon located in the side menu of the main selected UPS screen. A screen like Fig. 40a will be displayed, where the shown information can differ.

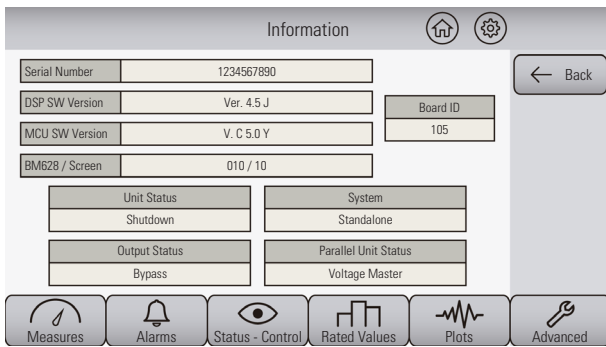

Fig. 40a. Screen displayed when touching over .

□ The information screen will be displayed. In this screen the UPS hierarchy can be checked under the statement «Parallel Unit Status» and in Fig. 40a it is shown as a «Parallel Master Voltage» example. It is necessary to go to the information menu of the touch screen of each UPS, in order to check its hierarchy as regards to the rest of the system, which is dynamic depending on the status of the rest of the equipments:

- «Parallel Master Bypass» Bypass Master of the parallel system. By default, it is the first UPS starts up the inverter by means of the established procedure.
- «Parallel Slave Bypass Reserve» Reserve Bypass. Initially corresponds to the highest address less the one already used for «Master Bypass». In case of Master failure, it will take its functions.
- «Parallel Slave Bypass» Bypass Slave of a parallel system (for systems based on two equipments only). It will be erected as «Slave Bypass Reserve», when it becomes «Master Bypass». In systems with more than three equipments in parallel, the «Slave Bypass Reserve» hierarchy will be set to the highest address among the «Slave Bypass» equipments.
- «Parallel Master Voltage» Voltage Master of the parallel system. By default, the first UPS on normal mode operating (inverter running), that the output switch (Q2) has been turned «On».
- «Parallel Slave Voltage Reserve» Voltage Slave Reserve of the parallel system. Equipment on normal mode operating (inverter running), that the output switch (Q2) has been turned «On» in 2nd place or later (after the «Parallel Master Voltage» or «Parallel Master Voltage Reserve»). Initially, it corresponds to the equipment with the highest address excluding the one with the «Master Voltage» function. In case of Master failure, it will take its functions.

- «Parallel Slave Voltage» Voltage Slave of the parallel system (systems with more than two equipments only). Equipment on normal mode operating (inverter running), that the output switch (Q2) has been turned «On» in 2nd place or later (after the «Parallel Master Voltage» or «Parallel Master Voltage Reserve»). It will be erected as «Slave Voltage Reserve», when it becomes «Master Voltage». In systems with more than three equipments in parallel, the «Slave Voltage Reserve» hierarchy will be done by the highest address among the «Slave Voltage» equipments.

- In the information screen quoted previously, there other particular data of the UPS, which are totally unconnected from its belonging to parallel systems or not like the serial number, driver versions, electronic card versions and their ID, irrelevant data for those tasks related with the start up.

In the same screen, there are other additional data under the statements as «Unit status» and «Output status», being them for information only.

- Turn the output switch or switches from the panel to «On», depending if it is a single equipment or parallel system.
- Turn the output switch (Q2) of the UPS or UPSs to «On». The equipment or parallel system will supply output voltage to the protection panel.

- For equipments with external battery cabinets, turn the fuse-holder switch of the battery cabinet/s (Q8) of each UPS to «On».

 **DO NOT TRY to make this manoeuvring at any other moment and/or in any other way, because it could damage the equipment and/or cause accidents.**

- When the rectifier is in operation completely, an equalising process will be started (the DC bus voltage will be equalised with the battery voltage).

After a few seconds (depending on the level of the batteries), the main menu will display the «Alarm» icon  in red colour with the acoustic alarm triggered.

- Touch over the «Alarm» icon .

- Check that in the alarm list, the message «Battery switch opened: Close it» can be found.

Touch over the «Alarm acknowledgement» icon  to acknowledge it and silent it.

This alarm message means that the equalising process has been finished and IN THIS MOMENT ONLY the battery switch or battery protection or both elements can be turned on:

- Equipments with only one battery mechanism, either a fuse-holder switch or battery switch and labelled in the illustrations of this document as (Q3). Turn it to «On».
- Equipments with two battery mechanisms, fuse-holder switch (F3) and isolator switch (Q3).
 1. First turn the battery fuse-holder switch (F3) to «On».
 2. Next, turn the battery isolator switch (Q3) to «On».

In parallel systems, repeat the process for each equipment.

 **DO NOT TRY to make this manoeuvring at any other moment and/or in any other way, because it could damage the equipment and/or cause accidents.**

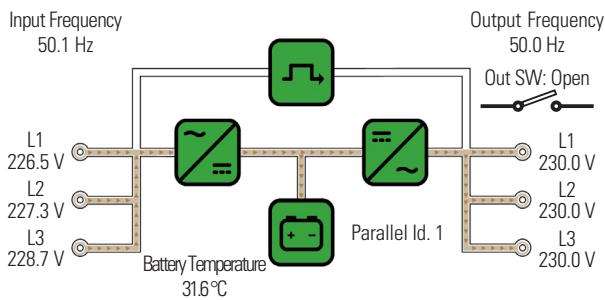

- In the main screen of the control panel of each equipment will be displayed a flow diagram like the one in Fig 41.

- If the equipment or parallel system has an outgoing distribution, start it up by turning the «On».
- Start up the loads to supply sequentially. The set is started up completely and the loads are protected by the UPS or by the UPS parallel system.



In the contents of the main screen, a flow diagram like Fig. 41 will be displayed, which corresponds to a III/III equipment with no separate bypass line. Nevertheless, depending on the input and output voltage typology of the equipment, either single or three phase, on the separate bypass availability or on its status, the flow diagram will change according to these variables, as well as the stated correlation voltages. In the ELO64*01 document there are shown other configurations as examples.

Fig. 45. Energy flow diagram of the control panel (PC).

-  After the commissioning, the daily start up and shutdown of the equipment or parallel system, will be done through the control panel keypad (PC). In parallel systems, it is only needed to act over one of them.
 -  Consider that the UPS or system will be still supplying output voltage, never mind the own inverter/s status:
 - When shutdown, loads supplied from static bypass.
 - When turned on, loads supplied from inverter (On-line mode).
 - When turned on, loads supplied from static bypass (Smart ECO Mode).

6.2.2.4. Considerations regarding Master and Slave (parallel systems only).

- Bypass Master and Slave, message:
 - In equipments with alphanumerical display («Mst. Byp.», «Slv. Byp.», «Slv. By.Rsv»).
 - In equipments with touch screen («Master Bypass», «Slave Bypass», «Slave Bypass Reserve»).
 - Master manages the status of the own solid state static bypass switch and the one of the Slave equipments.
 - The equipments are not sharing the load in the inverters. The cause can be any of the following:
 - Output switches (Q2) to position «Off».
 - Equipment output on bypass.
 - Inverters are shutdown or in start up process.
- Voltage Master and Slave, message:
 - In equipments with alphanumerical display («Mst. Volt», «Slv.

Volt», «Slv. Vt.Rsv»).

In equipments with touch screen («Master Voltage», «Slave Voltage», «Slave Voltage Reserve»).

- Master manages the status of the own solid state static bypass switch and controls the inverter voltage, as well as the one of the Slave equipments.
- Equipments are sharing the load in inverter. Therefore:
 - Output switches (Q2) are to «On» position.
 - Inverters are operative and solid state switches are on inverter.

6.3. SHUTDOWN OF AN EQUIPMENT FROM PARALLEL SYSTEM.

- Turn the output switch (Q2) of the UPS to shutdown, to position «Off».
 - In equipments with alphanumerical display the screen 0.1 can be checked:

UPS: Normal, Invert.
CFG: Paral. Not connected

screen 0.1

- In equipments with touch screen, press over the  icon located in the side menu of the main UPS screen.
 - The information screen will be displayed, where the UPS configuration can be checked in the statement «Parallel Unit Status» and the message «Parallel Not connected» will be displayed.

Regarding the boxes under the statements «Unit status» and «Output Status» will be displayed with the messages «Starting up» and «Inverter» respectively.

6.4. TO START UP THE UPS OF PREVIOUS SECTION.

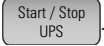
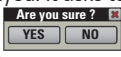
- For units with alphanumerical display.
 - Start up the inverter by means of the keypad of the control panel (3) (see Fig. 42).
 - From main screen press (▼) key to access to «CONTROL AND STATUS OF THE UNIT» submenu (screen 1.0), and then press (▶) key. The screen 1.1 will be displayed, asking you to start the equipment up by pressing (ENT). Do so, and then validate the operation by pressing (ENT) again. See the diagram of Fig. 39.
 - The UPS will take about 30 seconds to be operative again.
- For units with touch screen.
 - Start up the inverter of the equipment, to do it proceed as follows:
 - Touch over the «Status and control» icon .
 - Touch over the «Start/Stop UPS» icon .
 - The following «Pop up» message will be displayed. It asks to the end-user if he is sure about his selection  Confirm the action by touching over the «YES».
- Turn the output switch (Q2) of the UPS, to position «On».



6.5. COMPLETE SHUTDOWN OF THE UPS OR SYSTEM.

- Shutdown the loads.
- If the equipment or parallel system has an outgoing distribution, turn its switches «Off».
- Shutdown the inverter of the UPS.

For equipments with alphanumeric display.

Through the control panel keypad **(3)** (see Fig. 42) and from main menu, press the key **(▼)** to access to the «CONTROL AND EQUIPMENT STATUS» submenu (screen 1.0), and next press the key **(▶)**. The screen 1.3 will be displayed, where to stop the equipment the key **(ESC)** has to be pressed. Press the key and confirm the operation by pressing over **(ENT)**. See the diagram of Fig. 39.

For equipments with touch screen control panel.

- Touch over the «Status and control» icon .
- Touch over the «Start/Stop UPS» icon .
- The following «Pop up» message will be displayed, It asks to the end-user if it he is sure about his selection . Confirm the action by touching over «YES».

 In parallel systems is necessary to act over one of them only.

 Consider that the UPS or system is still supplying output voltage through the static bypass.

- Turn «Off» the output switch or switches of the panel board.
- Turn the output switch **(Q2)** of the UPS or each equipment of the system, to «Off» position.
- Turn the battery switch, battery protection or both elements «Off», considering both available topologies and the established order:

Equipments with a single battery mechanism, either with a battery fuse holder switch or battery switch and labelled in the figures of the present document as **(Q3)**.

Equipments with two battery mechanisms, fuse holder switch **(F3)** and switch **(Q3)**:

1. Battery fuse holder switch **(F3)** first.
2. Next the battery switch **(Q3)**.

In parallel systems, repeat the process in each equipment.

- For equipments with external battery cabinets, turn the fuse holder switch of the battery cabinet/s **(Q8)** of each UPS to «Off».
- In equipments or systems with separate static bypass line **SLC CUBE3+ B**:

Turn the bypass switch or switches of the panel board, to «Off».

Turn the bypass switch **(Q4a)** of the UPS or each equipment of the system, to «Off».

- Turn the input switch or switches of the panel board to «Off».
- Turn the input switch **(Q1a)** of the UPS or each equipment of the system, to «Off».
- Break the input power supply of the switchgear panel. The system will be completely deactivated.

-  **Electrical discharge hazard.** In case the battery cabinets or racks are required to be disconnect from UPS, wait several minutes (5 min. approx), till the electrolytic capacitors have been discharged.

6.6. EMERGENCY POWER OFF (EPO) BUTTON OPERATION.

Emergency Power Off (EPO) is equivalent to a complete shutdown:

- UPS converter or all converters of the system are shutdown (rectifier and inverter).
- No power supply is supplied to the loads.

The emergency power off (EPO) function can only be activated through the two pins terminal strip **(X50)**. In a parallel system, it is not needed to make more connections than the ones done in a single equipment, because through the communication BUS, any action over the button will affect to the complete parallel system.

E.P.O. function	Activation (It makes a shutdown of the system)	Normal mode is restored.
Terminal strip of two pins (X50) . Normally closed circuit by means of the cable as a bridge mode, which is supplied already connected between both pins of the terminal strip (it allows connecting an external (EPO) switch replacing the stated cable).	Remote button or switch that has to be always opened in the terminals (X50) .	The equipment has to be completely shutdown and deenergized (turn off all the switches), wait till the DC bus is discharged (all LEDs and LCD must be turned off). If remote button or switch at terminals (X50) , are closed in the circuit, the equipment has to be started up again as section "6.2.2.2. Procedure of start up" states.

Table 5. Emergency power off (EPO) operating.

6.7. SMART ECO MODE OPERATING.

For those less critical applications, the smart and efficient function «Smart ECO Mode», meanwhile the power supply is available, allows supplying the loads from mains directly through the solid state static bypass («Off Line» mode).





In case of power supply failure, the system will automatically shift to its normal operating mode («On Line») and loads will be fed from the inverter by the energy of the batteries. The «Smart ECO Mode» operating mode has efficiency benefits like having between a 4 and 4.5 % higher than in normal mode «On Line», so it will be close to the 100 %.

The «Smart ECO Mode» operating does not assure a perfect stabilization in frequency, voltage or sinewave shape (distortion) as in normal «On Line», because the figures of these parameters depend on the static bypass line and its set limits completely.

The detection of any of these parameters can take up to 3 ms, so it is recommended to assess the use of this operating mode, depending on the required protection level by the loads.



To activate the ECO Mode function, proceed as follows:

- For equipments with alphanumeric control panel.
 - This operating mode is disabled from factory and the end-user can activate it if he needs it, according to section 7.3.2. and Fig. 45.
- For equipments with touch screen control panel.
 - This operating mode is disabled from factory and the end-user can activate it if he needs it, as follows:

- Touch over the «Status and control» icon 
- Touch over the «Start/Stop ECO Mode» icon 
- The following «Pop up» message will be displayed, It asks to the end-user if it he is sure about his selection Confirm the action by touching over «YES» . 
- In the flow diagram of main screen the ECO Mode icon  will be displayed.

 The «Smart ECO Mode» operating mode is not available in parallel systems.

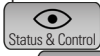
To deactivate the ECO Mode function and to put the inverter started up again, proceed as follows:

- For equipments with alphanumerical control panel.
 - Deactivate the ECO Mode function according to section 7.3.2. and Fig. 45.
- For equipments with touch screen control panel.
 - Touch over the «Status and control» icon 
 - Touch over the «Start/Stop ECO Mode» icon 
 - The following «Pop up» message will be displayed, It asks to the end-user if it he is sure about his selection Confirm the action by touching over «YES» . 

6.8. MANUAL BYPASS SWITCH (MAINTENANCE).



6.8.1. Operating principle.

The integrated manual bypass in the UPS is a very useful element, but undue use can have irreversible consequences both for the UPS or UPSs that make up the parallel system and for the loads connected to its output. Therefore, it is important to respect the manoeuvring over the switches as it is described in the following paragraphs.



6.8.2. Transference to maintenance bypass.

To shift from normal operating to maintenance bypass:

- Shutdown the inverter.
 - For equipments with alphanumerical control panel.

Through the keypad of control panel **(3)** (see Fig. 42) and from main screen press (▼) key to access to «CONTROL AND STATUS OF THE UNIT» submenu (screen 1.0), and then press (▶) key. The screen 1.3 will be displayed, asking you to shutdown the equipment by pressing **(ESC)**. Do so, and then validate the operation by pressing **(ENT)**. See the diagram of Fig. 39.
 - For equipments with touch screen control panel.
 - Touch over the «Status and control» icon 
 - Touch over the «Start/Stop UPS» icon 
 - The following «Pop up» message will be displayed, It asks to the end-user if it he is sure about his selection Confirm the action by touching over «YES» . 

 In parallel systems is necessary to act over one of them only.

-  Consider that the UPS or system is still supplying output voltage through the static bypass.
-  In parallel systems meanwhile the inverters are started up, if any manual bypass switch of the UPS or switchgear panel board is turned «On» by mistake, the power supply to the loads will be shifted to the input or bypass mains, ON CONDITION that the electrical connections of the auxiliary contacts of the manual bypass have been already done.
- Remove the screws (**t₂**) that fixes the mechanical block **(BL)** of the manual bypass switch, located in the switchgear panel board and take it out.
- Remove the screws (**t₂**) that fixes the mechanical block **(BL)** of the manual bypass switch **(Q5)** of the UPS or each UPS and take it/them out.
- Turn the manual bypass switch **(Q5)** of the UPS or each equipment, to «On» position. Those equipments with touch screen, it will be shown in the flow diagram of main screen with the  icon.
- Turn the manual bypass switch of the switchgear panel board to «On» position.
- Turn the output switch **(Q2)** of the UPS or each equipment, to «Off» position.
- Turn the output switch or switches of the switchgear panel board, to «Off» position.
- Turn the battery switch, battery protection or both elements «Off», considering both available topologies and the established order:
 - Equipments with a single battery mechanism, either with a battery fuse holder switch or battery switch and labelled in the figures of the present document as **(Q3)**.
 - Equipments with two battery mechanisms, fuse holder switch **(F3)** and switch **(Q3)**:
 1. Battery fuse holder switch **(F3)** first.
 2. Next the battery switch **(Q3)**.

In parallel systems, repeat the process in each equipment.

- For equipments with external battery cabinets, turn the fuse holder switch of the battery cabinet/s **(Q8)** of each UPS to «Off».
- In equipments or systems with separate static bypass **SLC CUBE3+ B**:

Turn the bypass switch **(Q4a)** of the UPS or each equipment, to «Off» position.

Turn the bypass switch or switches of the panel board to «Off» position.
- For **SLC CUBE3+** equipments:

Turn the input switch **(Q1a)** of the UPS or each equipment, to «Off» position.

Turn the input switch or switches of the panel board to «Off» position.

The UPS or system is completely shutdown and out of service (isolated), with the loads supplied from mains directly, through the manual bypass of the switchgear panel board.

UPS or system with no panel board, the loads are supplied from mains directly through the manual bypass of the equipments. Power supply comes from the input line in **SLC CUBE3+** or static bypass line in **SLC CUBE3+ B**.

6.8.3. Transference to normal operating, equipments with alphanumerical panel.

To shift from maintenance bypass to normal operating:

- For **SLC CUBE3+** equipments:
Turn the input switch or switches of the panel board to «On» position.
Turn the input switch (**Q1a**) of the UPS or each equipment, to «On» position.
- In equipments or systems with separate static bypass **SLC CUBE3+ B**:
Turn the bypass switch or switches of the panel board to «On» position.
Turn the bypass switch (**Q4a**) of the UPS or each equipment, to «On» position.
- Turn the output switch or switches of the switchgear panel board, to «On» position.
- Turn the output switch (**Q2**) of the UPS or each equipment, to «On» position.
- Equipments in parallel are set to Master or Slave, of bypass or voltage, as they were in the last setting.
- Wait till the static bypass of the equipment acts (bypass LED **(b)** lights -see Fig. 42).
- Turn the manual bypass switch of the switchgear panel board to «Off» position and put back the mechanical block (**BL**) and its fixing by means of the screw (**t₂**).
- Turn the manual bypass switch (**Q5**) of the UPS or each equipment, to «Off» position and put back the respective mechanical block (**BL**) and its fixing by means of the screw (**t₂**).
-  It is an essential safety requirement to refit the mechanical block or blocks (**BL**), as this avoids dangerous manoeuvring for the life of the UPS and loads connected to it.
- Start up the inverter by means of the keypad of the control panel (**3**) (see Fig. 42). In parallel systems, this operating can be done from any equipment.

From main screen press (▼) key to access to «CONTROL AND STATUS OF THE UNIT» submenu (screen 1.0), and then press (▶) key. The screen 1.1 will be displayed, asking you to start the equipment up by pressing (**ENT**). Do so, and then validate the operation by pressing (**ENT**) again. See the diagram of Fig. 39.

-  After the first start up, the usual start up/shutdown operation of an equipment or parallel joint will be done by means of the keypad of the control panel (**PC**). In parallel systems, will be needed to act over one of them only.

 Consider that the UPS or system will still be supplying output voltage, it does not matter the status of the own inverter or inverters:

- Shutdown, from static bypass.
- Started up, from inverter (On-line mode).
- Started up, from static bypass (on Smart ECO Mode).
- After about 30 seconds, the inverter and rectifier of the UPS or each UPS will be running and the output will supply voltage through the inverter or inverters.
- Make sure that the inverter ON LED indicator **(c)** lights (green), and bypass LED **(b)** is turned OFF (see Fig. 42).

If the status of the LEDs is wrong, please contact with the **T.S.S.** (Technical Service & Support).

- For equipments with external battery cabinet, turn the switch-fuse holder of the battery cabinet or cabinets (**Q8**) of each UPS to position «On».



DO NOT TRY to make this manoeuvring at any other time and/or in other way, because this operating could damage the equipment and/or cause accidents.

- Wait till the alarm message is displayed:

**BATT. SWITCH OPEN
SWITCH IT ON**

screen 4.*

- Battery switch, battery protection or both elements can only be turned «On» when the previous message is displayed in the screen, considering both available topologies and the established order:

- Equipments with a single battery mechanism, either with a battery fuse holder switch or battery switch and labelled in the figures of the present document as (**Q3**). Turn it «On».
- Equipments with two battery mechanisms, fuse holder switch (**F3**) and switch (**Q3**):
 1. Turn battery fuse holder switch (**F3**) «On» first.
 2. Next turn the battery switch (**Q3**) «On».

In parallel systems, repeat the process in each equipment.



DO NOT TRY to make this manoeuvring at any other time and/or in other way, because this operating could damage the equipment and/or cause accidents.

The UPS or parallel system supplies voltage at its output protected from mains faults, blackouts, voltage variations, electrical noises, etc. completely.

6.8.4. Transference to normal operating, for equipments with touch screen.

To shift from maintenance bypass to normal operating.

- For **SLC CUBE3+** equipments:
Turn the input switch/es of the panel to «On».
Turn the input switch (**Q1a**) of the UPS or each equipment to «On».
- In equipments or systems with separate static bypass line **SLC CUBE3+ B**:
Turn the bypass switch/es of the panel to «On».
Turn the bypass switch (**Q4a**) of the UPS or each equipment to «On».
- Turn the output switch/es of the protection panel to «On».
- Turn the output switch (**Q2**) of the UPS or each equipment to «On».
- The parallel equipments are set to Master or Slave, either bypass or voltage, as they were in the last setting.
- Wait till the static bypass is in operation. Visually, in the flow diagram shown in the main screen, can be checked that the energy flows through the static bypass.

- Turn the manual bypass switch of the protection panel to «Off» and put back the mechanical lock (BL) by fixing it with the screw (t₂).
- Turn the manual bypass switch (Q5) in the UPS or in each one to «Off» and put back their respective mechanical lock (BL) by fixing them with the screws (t₂).
-  For your safety, it is an essential requirement to put back the mechanical lock/s (BL), with the purpose of avoiding wrong manoeuvring for the UPS and connected loads.
- Start the inverter of the equipment/s up, to do it proceed as follows:

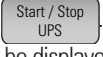
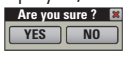
- Touch over the «Status and control» icon 
- Touch over the «Start/Stop UPS» icon 
- The following «Pop up» message will be displayed, It asks to the end-user if it he is sure about his selection . Confirm the action by touching over «YES».

-  After commissioning, the daily start up/shutdown operating of a single equipment or parallel system will be done through the touch screen of the control panel (PC). In parallel systems, it will only be needed to act over anyone of them.

 Consider that the UPS or system will still be supplying output voltage, regardless of the inverter/s status:

- Shutdown, loads are supplied from static bypass.
- Started up, loads are supplied from the inverter (On-line mode).
- Started up, loads are supplied from static bypass (Smart ECO Mode).
- After 30 seconds, the inverter and rectifier of the UPS or each UPS will start up, and the output will supply the inverter/s voltage.

- For equipments with external battery cabinets, turn the fuse-holder switch of the battery cabinet/s (Q8) of each UPS to «On».

 **DO NOT TRY to make this manoeuvring at any other moment and/or in any other way, because it could damage the equipment and/or cause accidents.**

- When the rectifier is in operation completely, an equalising process will be started (the DC bus voltage will be equalised with the battery voltage).

After a few seconds (depending on the level of the batteries), the main menu will display the «Alarm» icon  in red colour with the acoustic alarm triggered.

- Touch over the «Alarm» icon .
- Check that in the alarm list, the message «Battery switch opened: Close it» can be found.

Touch over the «Alarm acknowledgement» icon  to acknowledge it and silent it.

This alarm message means that the equalising process has been finished and IN THIS MOMENT ONLY the battery switch or battery protection or both elements can be turned on:

- Equipments with only one battery mechanism, either a fuse-holder switch or battery switch and labelled in the illustrations of this document as (Q3). Turn it to «On».
- Equipments with two battery mechanisms, fuse-holder switch (F3) and isolator switch (Q3).

1. First, turn the battery fuse-holder switch (F3) to «On».

2. Next, turn the battery isolator switch (Q3) to «On». In parallel systems, repeat the process for each equipment.

 **DO NOT TRY to make this manoeuvring at any other moment and/or in any other way, because it could damage the equipment and/or cause accidents.**

In the main screen of the control panel of each equipment will be displayed a flow diagram like the one in Fig 41.

The UPS or parallel system supplies voltage at its output, which is protected against mains failures, blackouts, voltage fluctuations, electrical noises, etc.

7. DESCRIPTION OF THE CONTROL PANEL.

- 
The menu tree and operating described in this section corresponds to equipments with alphanumerical panel only.

For units with touch screen make the respective counterpart actions, while the procedure is easier due to the grouping of the different steps to follow in only screen or to a more direct operating. Interact as the EL064*01 user's manual states.

7.1. CONTROL PANEL PARTS.

- (1) LED indicators:
- (a) Rectifier input voltage OK (green).
 - (b) Equipment on bypass (orange).
 - (c) Inverter ON (green).
 - (d) Equipment running from batteries -mains failure- (red).
 - (e) In case of any alarm of the equipment (red).
- (2) LCD screen.
- (3) Keypad
- ENT** «Enter» key. Confirmation of orders, program values (or other specified functions)
- (◀) «Left» key for submenu navigation, or cursor moving.
- (▶) «Right» key for submenu navigation, or cursor moving.
- (▲) «Up» key for menu navigation, or character modification.
- (▼) «Down» key menu navigation, or character modification.
- ESC** «Escape» key. Return to main screen, cancel/finish programming (or other specified functions).

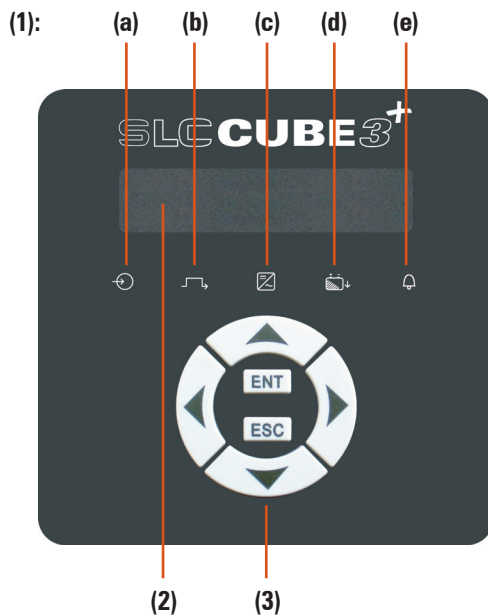

Fig. 46. Control panel parts, according to the model

7.2. BASIC FUNCTIONS OF THE SYNOPTIC KEYPAD.

- Through keys advance (▼) and return (▲), there is access to all the menus of the LCD panel, being able to move from one to another.
- Through keys right (▶) or left (◀), there is access to the screens of all the submenus of the LCD panel, being able to move from one to another with themselves.
- Key (**ENT**), has different purposes depending on the menu we are:
 - Setting values. Press key (**ENT**) to activate the setting function, the figures in the screen blink. With keys (▶)-(◀) the character to set is selected and with keys (▼)-(▲) the value is selected. To confirm press (**ENT**). Next field will blink, to continue doing settings proceed in the same way or press (**ESC**) to return to no-setting situation.
 - Validation of orders or commands.
- When pressing key (**ESC**) from any screen of any submenu, it is gone back to main screen (**Screen 0.0**), unless we are in any screen of «**Parameters**» menu and setting any of them. If so, the first pulsation of key (**ESC**) will stop blinking the value, and second one will go back to main screen.
- Notes related with the screen map (see Fig. 42):
 - Some screens have a certain number of «→» characters. Each one of it, means one character, so the maximum length of the field will be determined by the quantity of them.
 - Each screen is labelled with a number located in its right bottom corner. It is only included as a mere reference for its next description and explanation.
 - Note (*1): it means the hidden programming screens through password (*****) in «**screen 1...**». This safety level avoids that non-authorized staff can alter or modify any setting



7.2.1. Messages menus and classification of the submenu.

- Use (▼) and (▼) keys to choose between different menus (0.0, 1.0, ..., 7.0).
- Use (▶) and (◀) keys to move inside submenu screens.

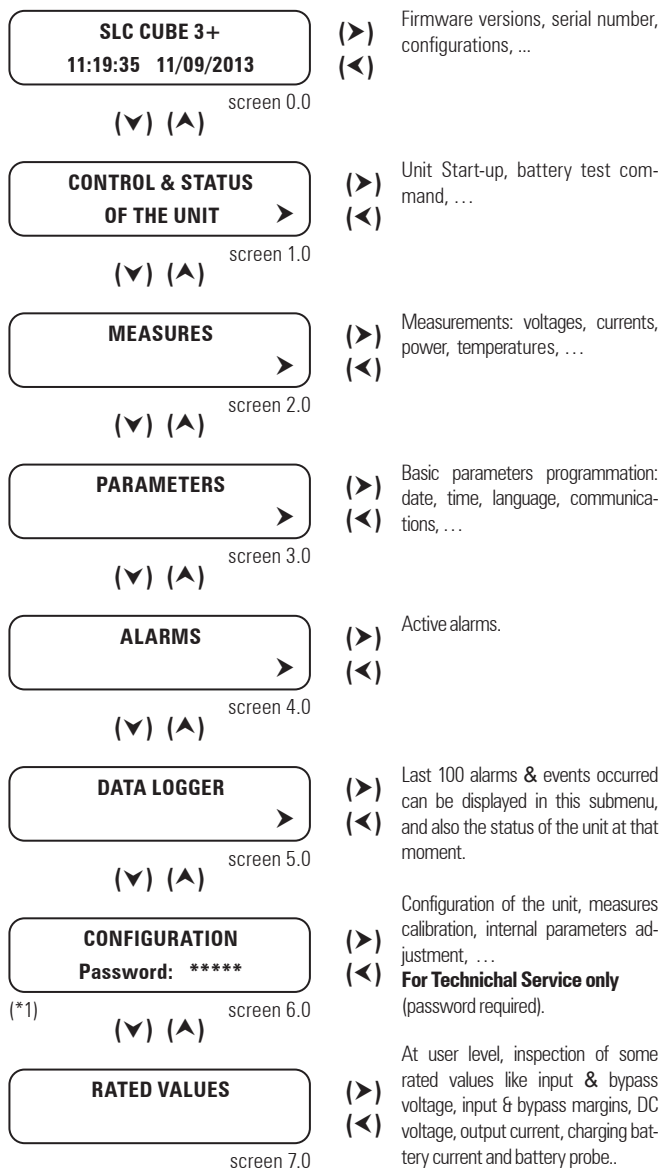
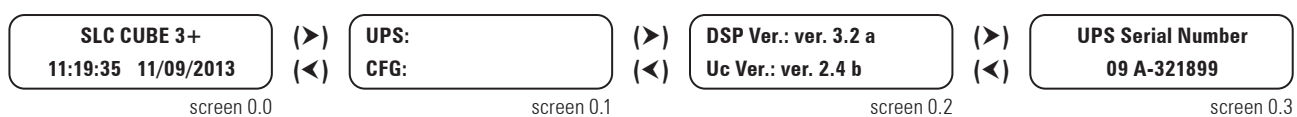

Fig. 47. Classification of the menu and submenus displayed in the LCD panel.

7.3. SCREEN DESCRIPTION.

7.3.1. Main level (screen menu 0.0). See Fig 44.

- **Screen 0.0:** Main presentation screen, with time and date indication.



When pressing key **(ESC)** from any screen of any submenu, it is gone back to main screen (**Screen 0.0**).

Fig. 48. Screen 0.0 «Start» and its submenus.

- **Screen 0.0:** In parallel equipments, the first row of the screen changes between "SLC CUBE3+" and "Paral.-- Out.SW=---", and where:

- Paral. ---, corresponds to the address of each UPS with three characters.
- Out.SW ---, corresponds to the position of the output switch of the UPS and/or switchgear panel board, with two status ON and OFF (the auxiliary contact of the output switch in the output panel board has to be connected according to the instructions of section 5.2.9.2.).

- **Screen 0.1:** UPS Status ("UPS:", 1st row) and configuration ("CFG:", 2nd row). In the first row, there are two fields, first one shows the general state of the converters, and second one shows the origin of the voltage at the output. These two fields are separated by a " , ":

- Possible states of the converters:
 - «Shutdown» Rectifier and Inverter stopped or blocked.
 - «Start up» UPS converters (rectifier and inverter) are started up, but not ready yet.
 - «Normal» UPS is running in normal mode: mains present, rectifier running, output on inverter, loads are protected.
 - «Discharge» Mains failure. UPS running on back-up mode (rectifier shutdown, inverter running).
- Origin of the output:
 - «OFF» No voltage supplied at the output (either EPO pressed, or severe problem in the equipment).
 - «Invert» Inverter voltage is supplied at the output. Loads are protected.
 - «Bypass» Bypass voltage is supplied at the output. Either the equipment is manually shutdown, or overloaded, or other possible problem in the inverter.

In the second row, there is the hierarchy of the UPS as regards to the rest of the system, which is dynamic depending on the status of the rest of the equipments. For «Single» equipment, the LCD will display the message «CFG: Single»

- Equipment hierarchy (parallel systems):
 - «Paral. Mst. Byp» bypass Master of the parallel system. By default, the first UPS starting up the inverter according to the established procedure.
 - «Paral. Slv. By.Rsv» reserved bypass Slave. Initially corresponds to the equipment with the highest address excepting the one from «bypass Master». In case of failure of the Master, it will take its functions.
 - «Paral. Slv. Byp» bypass Slave of the parallel system (systems with more than two equipments only). It will become as «reserved bypass Slave», when it practise as «bypass Master». In systems with more than three

equipments in parallel, the hierarchy of «reserved bypass Slave» will be taken by the one with the highest address among the «bypass Slave».

- «Paral. Mst. Volt» voltage Master of the parallel system. By default, the first UPS on normal operating (inverter in operation), that the output switch (**Q2**) is turned «On».
- «Paral. Slv. Vt.Rsv» reserved voltage Slave of the parallel system. Equipment on normal operating (inverter in operation), that the output switch (**Q2**) is turned «On» in 2nd place or subsequently (after the «Paral. Mst. Volt» or «Paral. Mst. Vt.Rsv»). Initially, it corresponds to the equipment with the highest address, excepting the one from «Voltage Master». In case of failure of the Master, it will take its functions.
- «Paral. Slv. Volt» voltage Slave of the parallel system (systems with more than two equipments only). Equipment on normal operating (inverter in operation), that the output switch (**Q2**) is turned «On» in 2nd place or subsequently (after the «Paral. Mst. Volt» or «Paral. Mst. Vt.Rsv»). It will become as «reserved voltage Slave», when it practise as «voltage Master». In systems with more than three equipments in parallel, the hierarchy of «reserved voltage Slave» will be taken by the one with the highest address among the «voltage Slave».

Examples:

a)

UPS: Normal, Invert.
CFG: Mst. Volt

b)

UPS: Shutdown, Off
CFG: Mst. Byp

- **Screen 0.2:** Internal firmware versions of both Digital Signal Processor ("DSP Ver:") and microcontroller ("uC Ver:"). In the sample screen, "ver. 3.2 a" and "ver. 2.4 b" respectively.
- **Screen 0.3:** UPS Serial Number, expressed with 10 characters. Possible characters ranges are "0"- "9", "A"- "Z" and also " " (blank space), "-". See sample screen.

7.3.2. "CONTROL AND STATUS OF THE EQUIPMENT" level
See Fig 45.

-  **The operating described in this section corresponds to equipments with alphanumerical panel only. For those units with touch screen control panel, follow the same steps and when it is needed any operating that involve any action over it, interact according to EL064*01 document.**
- **Screens 1.1, 1.3 and validation screen (1.2 / 1.4):** to start up and shutdown the equipment through the control panel.
To start up and shutdown the equipment, see sections 6.2 to 6.5.
- **Screen 1.5 and validation screen (1.2 / 1.4):** to order a battery test. On the second row, information about the battery test is given. Possible messages:
"NOT AVAILABLE": The battery test is not available.
"PRESS <ENTER>": Press <ENTER> to start the battery test.
"EXECUTING": The battery test is running.
"SUCCESSFUL": The battery test has been successful.
"NOT SUCCESSFUL": The battery test has not been successful.
- **Screens 1.6, 1.8 and validation screen (1.7 / 1.9):** to activate and deactivate the Smart ECO Mode operating, described in section 6.7 respectively.

7.3.3. "MEASUREMENT" level (screen menu 2.0). See fig. 46.

Due to the four different factory settings of the UPS:

- 1.- Three phase input / Three phase output (III/III).
- 2.- Three phase input / Single phase output -N- (III/I).
- 3.- Single phase input /Single phase output -L- (I/I).
- 4.- Single phase input /Three phase output -M- (I/III).

... the quantity of displays screens and their respective measurements can vary depending on each case.

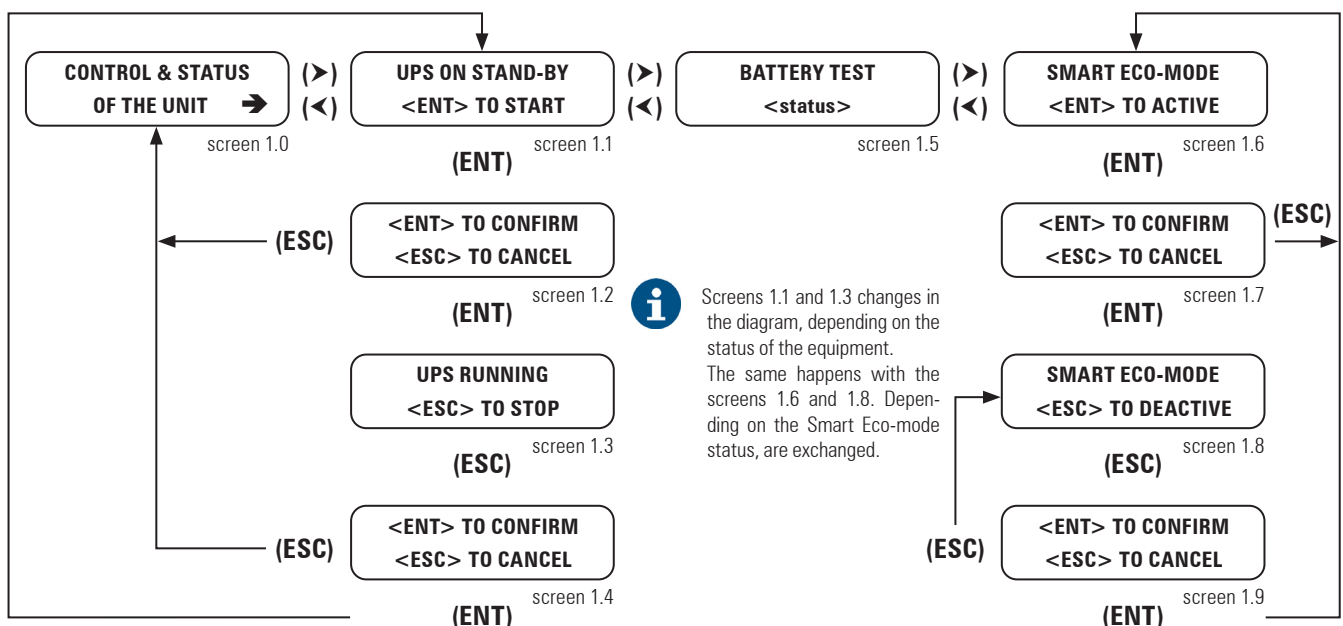

Screens 1.1 and 1.3 changes in the diagram, depending on the status of the equipment. The same happens with the screens 1.6 and 1.8. Depending on the Smart Eco-mode status, are exchanged.

Fig. 49. Screen submenu 1.0. Start up / shutdown.

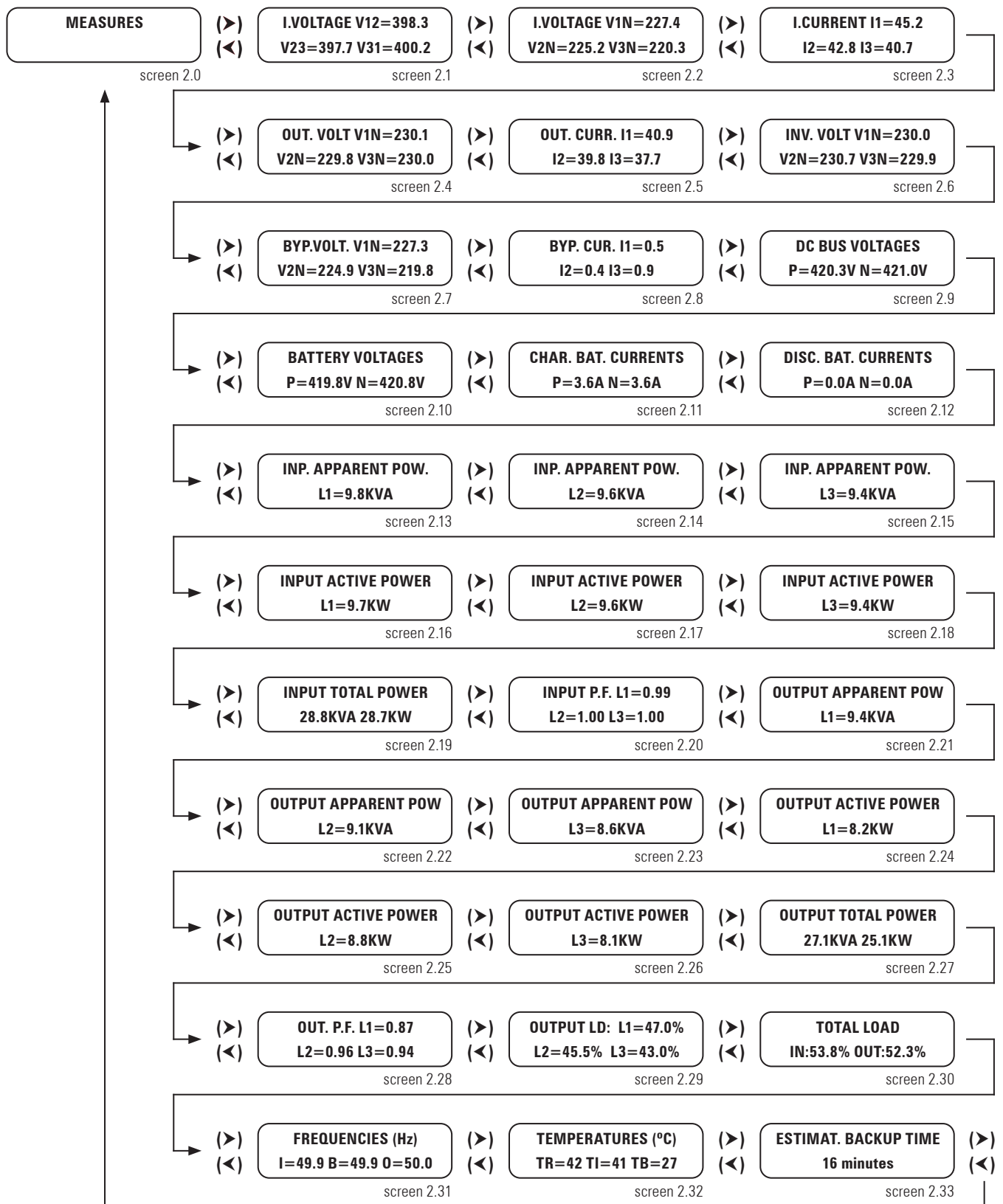

By pressing **(ESC)** key from any screen of any submenu, it is gone back to main screen **(Screen 0.0)**.

Fig. 50. Screen 2.0 «Measurements» and its submenus.

Table 6 shows the screens that ARE NOT AVAILABLE in some settings, taking the “three phase input / three phase output” setting as maximum conceptual exponent and represented in submenu of Fig. 46, which shows the measurement figures as an example.

For frequency converters and single phase equipments, the displayed measurements will be according to its condition.

-  Displayed measurements in screens 2.1 to 2.8, 2.20, 2.28 and 2.29 will be according to the input and output topologies, depending if they are single phase (there will be one figure only in the LCD panel) or three phase (there will be three figures that correspond to the three phases).

NOT AVAILABLE measurement screens for each setting are stated in table 6.

NOT AVAILABLE measurement screens according to UPS setting.			
(III / III)	-N- (III / I)	-L- (I / I)	-M- (I / III)
-	-	2.1	2.1
-	-	2.13	2.13
-	-	2.14	2.14
-	-	2.15	2.15
-	-	2.16	2.16
-	-	2.17	2.17
-	-	2.18	2.18
-	2.21	2.21	-
-	2.22	2.22	-
-	2.23	2.23	-
-	2.24	2.24	-
-	2.25	2.25	-
-	2.26	2.26	-
-	2.29	2.29	-



-  In case of being a frequency converter, a part from the NOT AVAILABLE screens according to the setting, the following ones will not be available too:
- Converter with batteries: 2.7 and 2.8.
 - Converter with no batteries: 2.7, 2.8, 2.10, 2.11, 2.12 and 2.33.

Table 6. NOT AVAILABLE measurement screens according to the UPS setting.

- **Screen 2.1:** input voltages phase to phase (units 0.1 V).
- **Screen 2.2:** three phase input voltages phases to neutral or for single phase input phase to neutral (units 0.1 V).
- **Screen 2.3:** input current per each phase for three phase equipments or for the phase for single phase equipment (units 0.1 A).
- **Screen 2.4:** three phase output voltages phases to neutral, or for single phase output phase to neutral (units 0.1 V).
- **Screen 2.5:** output current per each phase for three phase equipments or for the phase for single phase equipment (units 0.1 A).
- **Screen 2.6:** three phase inverter output voltages phases to neutral, or for single phase inverter output phase to neutral (units 0.1 V).
- **Screen 2.7:** three phase bypass voltages phase to neutral or for single phase bypass phase to neutral (units 0.1 V).
- **Screen 2.8:** bypass current per each phase for three phase equipments or for the phase for single phase equipment (units 0.1 A).
- **Screen 2.9:** positive and negative DC bus voltages (units 0.1 V).
- **Screen 2.10:** positive and negative battery voltages (units 0.1 V).

- **Screen 2.11:** positive and negative battery charging currents (units 0.1 A).
- **Screen 2.12:** positive and negative battery discharging currents (units 0.1 A).
- **Screen 2.13:** input apparent power of L1 (units 0.1 kVA).
- **Screen 2.14:** input apparent power of L2 (units 0.1 kVA).
- **Screen 2.15:** input apparent power of L3 (units 0.1 kVA).
- **Screen 2.16:** input active power of L1 (units 0.1 kW).
- **Screen 2.17:** input active power of L2 (units 0.1 kW).
- **Screen 2.18:** input active power of L3 (units 0.1 kW).
- **Screen 2.19:** total input apparent power and active power (units 0.1 kVA and 0.1 kW).
- **Screen 2.20:** input power factor of each phase in three phase equipments or input power factor for single phase equipments (units 0.01).
- **Screen 2.21:** apparent output power of L1 (units 0.1 kVA).
- **Screen 2.22:** apparent output power of L2 (units 0.1 kVA).
- **Screen 2.23:** apparent output power of L3 (units 0.1 kVA).
- **Screen 2.24:** active output power of L1 (units 0.1 kW).
- **Screen 2.25:** active output power of L2 (units 0.1 kW).
- **Screen 2.26:** active output power of L3 (units 0.1 kW).
- **Screen 2.27:** total apparent and active powers (units 0.1 kVA and 0.1 kW).
- **Screen 2.28:** output power factor of each phase for three phase equipments or output power factor for single phase equipments (units 0.01).
- **Screen 2.29:** total load of three phases (units 0.1%).
- **Screen 2.30:** total input and output load (units 0.1%).
- **Screen 2.31:** input, bypass and output frequencies (units 0.1 Hz).
- **Screen 2.32:** rectifier, inverter and battery temperatures (units 1 °C).
- **Screen 2.33:** estimated backup time (units 1 minute).

-  Displayed measurements in screens 2.1 to 2.8, 2.20, 2.28 and 2.29 will be according to the input and output topologies, depending if they are single phase (there will be one figure only in the LCD panel) or three phase (there will be three figures that correspond to the three phases).

7.3.4. "PARAMETERS" level (screen menu 3.0). See fig 47.

- **Screen 3.1:** In the first row, the time "hh:mm:ss" (hours/minutes/seconds) can be set and in the second row the date "dd/mm/yy" (day/month/year) can be set.
- **Screen 3.2:** In the first row, the display language can be selected. Options:
 - "English"
 - "Spanish"
 - "French"
 - "German"
 - "Turkish"
 - "Russian"

In the second row, the Modbus Address can be set. The range of addresses goes from 1 to 247.

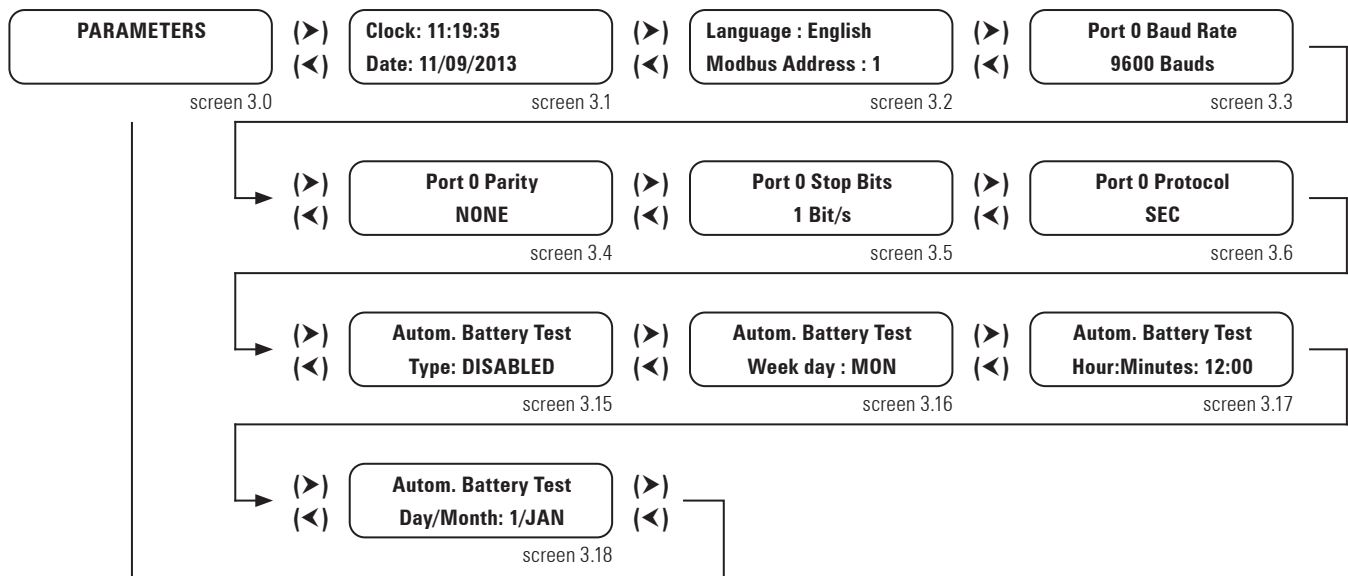

By pressing **(ESC)** key from any screen of any submenu, it is gone back to main screen **(Screen 0.0)**.

Fig. 51. Screen 3.0 «Parameters» and its submenus.

- **Screen 3.3:** This screen allows setting the BAUD RATE of communication port #0. Options:
 - "1200"
 - "2400"
 - "4800"
 - "9600"
 - "19200"
- **Screen 3.4:** This screen allows setting the PARITY type of communication port #0. Options:
 - "NONE"
 - "ODD"
 - "EVEN"
- **Screen 3.5:** This screen allows setting the number of STOP BITS of communication port #0. Options:
 - "1"
 - "2"
- **Screen 3.6:** This screen allows setting the protocol type of communication port #0. Options:
 - "SEC"
 - "MODBUS"
- **Screen 3.15:** This screen allows setting the frequency of the automatic battery test. Options:
 - "DISABLED": The automatic battery test is disabled.
 - "WEEKLY": The automatic battery test runs once per week.
 - "MONTHLY": The automatic battery test runs once per month.
 - "YEARLY": The automatic battery test runs once per year.
- **Screen 3.16:** Weekday when the battery test is done. Options:
 - "MON": For Monday.
 - "TUE": For Tuesday.
 - "WED": For Wednesday.

- "THU": For Thursday.
- "FRI": For Friday.
- "SAT": For Saturday.
- "SUN": For Sunday.

- **Screen 3.17:** This screen allows setting the time "hh:mm" (hours/minutes) in 24h format of the automatic battery test.
- **Screen 3.18:** This screen allows setting the day from 1 to 31 and the month of the automatic battery test according to one. Options:
 - "JAN": For January.
 - "FEB": For February.
 - "MAR": For March.
 - "APR": For April.
 - "MAY": For May.
 - "JUN": For June.
 - "JUL": For July.
 - "AUG": For August.
 - "SEP": For September.
 - "OCT": For October.
 - "NOV": For November.
 - "DEC": For December.

7.3.5. "ALARMS" level (menu screen 4.0). See Fig 48.

By means of key **(▶)** active alarms are displayed, being able to move from one to another inside of the alarm list with the keys **(▶)** or **(◀)**.

If there is not any alarm, it will not be possible to go forward with key **(▶)**.

Fig. 48 shows just only one alarm as an example, but there could be some of them active at the same time.

In table 7, there are all the possible alarms displayed in the LCD panel.

Also, alarm message screens may appear blinking and replacing any other screen (even if is a in different menu or submenu) currently displayed.

By pressing (**ENT**), blinking alarm message is acknowledged and previous screen is displayed again.



Fig. 52. Screen 4.0 «Alarms» and its submenus.

i Any alarm displayed in the alphanumeric panel triggers the acoustic alarm with the same modulation and intensity for all of them.

- **Screen 4.1:** This alarm indicates that the rectifier is overloaded. The rectifier overload appears when the input current of any phase is higher than the following ratio:

$$I_{in-ovl} = 0,326 \times P_{nom} / V_{in_p-n}$$

Where:

- I_{in-ovl} is Overload Input Current (A).
- P_{nom} , is the nominal power rate of the equipment (VA).
- V_{in_p-n} , is the input voltage phase to neutral (V).

- **Screen 4.2:** This alarm indicates that the inverter is overloaded. The inverter overload appears when the output current of any phase is higher than the following ratio:

$$I_{out-ovl} = P_{nom} / (V_{out_nom_p-n} * 3)$$

Where:

- $I_{out-ovl}$, is the Overload Output Current (A).
- P_{nom} , is the nominal power rate of the equipment (VA).
- $V_{out_nom_p-n}$, is the nominal output voltage phase to neutral (V).

or when the total output active power is higher than the following formula:

$$P_{act_out-ovl} = P_{nom} \times 0.9$$

Where:

- $P_{act_out-ovl}$, is the overload output active power (W).
- P_{nom} is the nominal power rate of the equipment (VA).
- 0.9 for UPS III/III or CF and 0.8 for versions L, M, N or AUTO.

- **Screen 4.3:** This alarm is displayed when the equipment is both under main failure condition and battery level lower than 11.5V/bat.
- **Screen 4.4:** This alarm is displayed when the inverter output voltage in any phase (phase to neutral) is out of the range +/-6 %.
- **Screen 4.5:** This alarm is displayed when there is an offset voltage higher than 5V, in any phase of the inverter output voltage (phase to neutral).
- **Screen 4.6:** When the maintenance bypass switch is ON the

UPS inverter will not be available.

- **Screen 4.7:** This alarm can be activated for two reasons:
 - a) Mains failure: when phase to neutral voltage in any input phase is out of range (+15%/–20% by default) or when input frequency is out of range (± 5 Hz by default).
 - b) PFC-rectifier is on limiting power mode, so, the additional energy that the Inverter needs (it means the load connected at the output of the equipment), is supplied by the batteries (battery discharging current is displayed).
- **Screen 4.8:** When the inverter or PFC temperature probes measure temperatures over the set values.
- **Screen 4.9:** This message is displayed when the battery switch is OFF and the DC bus is charged to the battery voltage level, to inform the user that battery switch can be turned ON.
- **Screen 4.10:** This screen indicates that the bypass input voltage or the bypass input frequency are out of range. These ranges can be set but by default the bypass voltage range is +12 %/–15 % and the bypass frequency range is ± 5 Hz.
- **Screen 4.11:** The UPS is on bypass for any reason. It must be restarted by LCD panel keypad.
- **Screen 4.12:** This is an alarm for parallel systems. It is displayed when any UPS of the parallel system is blocked because its maintenance bypass switch is turned ON.
- **Screen 4.13:** This alarm indicates that the CAN BUS #1 fails. This communication channel is not available currently.
- **Screen 4.14:** This alarm indicates that the CAN BUS #2 fails. This channel is used for data communication among the UPSs in a parallel system.
- **Screen 4.15:** This alarm is displayed when the estimated battery life time has been exhausted. The revision and replacement of some batteries will be necessary, which has to be done by the **T.S.S.** (Technical Service & Support) department.
- **Screen 4.16:** The temperature of battery cabinet (in case of separate battery cabinet) or battery location (in case of batteries are located inside the UPS) is higher than 40° C.
- **Screen 4.17:** If battery test (automatic or manual) is finished unsuccessfully, this alarm will be displayed.
- **Screen 4.18:** Two possible reasons:
 - During the unit start up, a message is displayed indicating that the battery switch can be turned ON. After some period of time without turning ON, this alarm is displayed.
 - When the unit is running under normal conditions, and the battery switch is switched OFF.
- **Screen 4.19:** When the mains is connected during the start up, a wrong phase rotation is detected, so the start up procedure is inhibited.
- **Screen 4.20:** When the bypass is connected during the start up and a wrong phase rotation is detected, so the start up procedure is inhibited.
- **Screen 4.20A:** Error in the memory of the equipment setting.

Representation in display LCD	Alarms	Ref.	
RECTIFIER OVERLOAD	RECTIFIER	4.1	
INVERTER OVERLOAD	INVERTER	4.2	
MAINS FAILURE LOW BATTERY LEVEL		4.3	
INVERTER VOLTAGE OUT OF MARGINS		4.4	
DC VOLT. DETECTED AT THE OUTPUT		4.5	
MAINTENANCE BYP. INVERTER NOT AVAIL.		4.6	
BATTERY DISCHARGING		UPS	4.7
HIGH TEMPERATURE REDUCE OUTPUT LOAD	4.8		
BATT. SWITCH OPEN SWITCH IT ON	4.9		
BYPASS FAILURE NOT SYNCHRONISED INV	4.10		
UPS ON BYPASS INITIALISE THE UPS	4.11		
SOME UNIT BLOCKED DUE TO MAINT. BYPASS	4.12		
CAN BUS 1 COMMUNICATION FAIL.	4.13		
CAN BUS 2 COMMUNICATION FAIL.	4.14		
END OF BATTERY LIFE ALARM	4.15		
BATT. TEMPERATURE TOO HIGH	4.16		
BATTERY TEST NOT SUCCEEDED	4.17		
BAT. DISCONNECTION SHUTDOWN & RESTART	4.18		
MAINS PHASE ROT. UPS START INH.	4.19		
BYPASS PHASE ROT. UPS START INH.	4.20		
EEPROM MEMORY FAILURE.	4.20A		
ERROR COMS. PARAL. MASTER FIXED	PARALLEL		4.21
ALARM PARAL. SIST. REDUNDANCY LOST			4.22
INP. VOLTA. WRONG RECTIFIER STOP	RECTIFIER STOPS		4.23
RECTIFIER DESATS. RECTIFIER STOP			4.24
DSP INTERN. ERROR RECTIFIER STOP		4.25	
INPUT PHASE ROT. RECTIFIER STOP		4.26	
DC BUS VOLT WRONG RECTIFIER STOP		4.27	
PARALLEL SIST. RECTIFIER STOP		4.28	
CONT. TEST FAIL RECTIFIER STOP		4.29	

Representation in display LCD	Alarms	Ref.
INVERTER DESATS. INVERTER STOP	INVERTER STOPS	4.30
INVERTER OVERLOAD INVERTER STOP		4.31
SHUTDOWN COMMAND INVERTER STOP		4.32
MAINTENANCE BYP. INVERTER STOP		4.33
PARAL. SYS. DISC. INVERTER STOP		4.34
HIGH OVERLOAD INVERTER STOP		4.35
OVERTEMPERATURE INVERTER STOP		4.36
RECTIFIER OVERLO. INVERTER STOP		4.37
DSP INTERN. ERROR INVERTER STOP		4.38
OUT SHORT-CIRCUIT INVERTER STOP		4.39
BYPASS PHASE ROT. INVERTER STOP		4.40
INV. FAILURE/OVL INVERTER STOP		4.41
VOLTAGE RAMP ERR. INVERTER STOP		4.42
PARALLEL SYSTEM INVERTER STOP		4.43
LOW BATTERY INVERTER STOP	4.44	
DSP INTERN. ERROR UPS STOP	UPS STOPS	4.45
OVERTEMPERATURE UPS STOP		4.45A
PFC & INV STOP UPS STOP		4.46
PARALLEL SIST. UPS STOP	4.47	
EMERGE. POWER OFF NO OUTPUT VOLTAGE	BYP STOPS	4.48
OUT SHORT-CIRCUIT NO OUTPUT VOLTAGE		4.49
DSP INTERN. ERROR UPS BLOCK ALL	4.50	
DC BUS VOLT WRONG RECTIFIER BLOCK	RECTIFIER BLOCKS	4.51
RECTIFIER BLOCKED BLK. UPS -> BLK. REC		4.52
RECTIFIER DESATS. RECTIFIER BLOCK		4.53
VOLTAGE RAMP ERR. RECTIFIER BLOCK		4.54
INTERN. EXE. ERROR RECTIFIER BLOCK		4.55
DSP INTERN. ERROR RECTIFIER BLOCK		4.56
CONTACTOR T. FAIL RECTIFIER BLOCK		4.57
VOLTAGE RAMP ERR. INVERTER BLOCK	INVERTER BLOCKS	4.58

Representation in display LCD	Alarms	Ref.
OUTPUT DC VOLTAGE INVERTER BLOCK	INVERTER BLOCKS	4.59
INVERTER BLOCKED BLK. UPS -> BLK. INV		4.60
INVERTER DESATS. INVERTER BLOCK		4.61
INTERN. EXE. ERROR INVERTER BLOCK		4.62
DSP INTERN. ERROR INVERTER BLOCK		4.63
INVERTER FAILURE INVERTER BLOCK		4.64
UPS BLOCKED BLK. REC -> BLK. UPS	UPS BLOCKS	4.65
INTERN. INI. ERROR UPS BLOCK (DSP)		4.66
INTERN. EXE. ERROR UPS BLOCK (DSP)		4.67
UPS BLOCKED BLK. INV -> BLK. UPS		4.68
INTERN. COM. ERROR UPS BLOCK (DSP)		4.69
DC BUS WRONG DISC. UPS BLOCK		4.70
UPS OVERTEMPERAT. UPS BLOCK		4.71
RECTIFIER OVERLO. UPS BLOCK		4.72
INVERTER DESATS. UPS BLOCK		4.73
DSP INTERN. ERROR UPS BLOCK		4.74
PFC & INV BLOCK. UPS BLOCK		4.75
PARAL. COMS ERROR UPS BLOCK		4.76
FREQ. DET. FAIL UPS BLOCK		4.77

Table 7. Alarm list displayed in the LCD panel.

- **Screen 4.21:** In a system with parallel configuration, this alarm is displayed in one of the equipments (or some) that detect communication errors, due to several reasons (parallel communication cables are disconnected, or wrong connected, or in bad status; wrong configuration of any of the equipments; etc.). Therefore, one of the equipments is set as a fix Master of the system, and the rest of the equipments can only be slaves permanently (or till the equipments are shutdown and try to started them up again).
- **Screen 4.22:** In a parallel system, with N+M configuration, where:
 - N: nr equipments to size the system according to the maximum permissible load.
 - M: nr redundant equipments in the system. It is equivalent to over sizing the equipments in the system, in order to continue supplying the maximum permissible load without overloading it. Usually, this value is fixed to "1".

The alarm is displayed when the load exceeds the maximum permissible load by N equipments. In this condition, the equip-

ments will not be overloaded individually, meanwhile the load doesn't exceed the maximum load of N+M equipments.

Example: Assuming that a parallel system of 2+1 equipments of 20kVA (N=2, M=1).

- If the load of the system is lower than 40kVA. Any overload alarm is displayed in the system (if it is not exceeded the individual overload per phase of each equipment).
- If the load of the system is higher than 40kVA. The described alarm 4.22 of Lost of Redundancy is displayed.
- If the load of the system is higher than 60kVA. Besides of the alarm 4.22 of Lost of Redundancy, there will also be, as minimum, (among others), the alarm 4.2 of Inverter overload in all the equipments of the system.
- **Screen 4.23:** This alarm is displayed when in any phase, the rectifier input voltage phase to neutral is out of the set range (+15 % / -20 % by default) or the rectifier input frequency is out of the set range (\pm 5 Hz by default). Next, the rectifier is shutdown.
- **Screen 4.24:** This alarm is displayed when the quantity of IGBT desaturations in the rectifier stage, reaches its limit.
- **Screen 4.25:** This alarm is displayed when there is a (*) DSP Internal Error in the rectifier module, shutting down the rectifier immediately. There will be 3 more retries before blocking rectifier.
- **Screen 4.26:** When a wrong phase rotation is detected in the mains and under these conditions the rectifier is tried to be turned ON, an input phase rotation alarm is displayed shutting down the rectifier immediately.
- **Screen 4.27:** When a high or low DC bus voltage of the equipment is detected, the rectifier is shutdown for a while, in order to retry to start up later on (see description of screen 4.51 too).
- **Screen 4.28:** In a parallel system, rectifiers from the equipments of the system connected in parallel can be shutdown, due to the management of system as a whole, therefore this alarm is displayed.
- **Screen 4.29:** This alarm can be displayed for two reasons:
 - Input contactor from the equipment faults (it doesn't close properly). It is shown when the DC bus voltage, it is not kept at certain level when turning on such input contactor.
 - If for any reason, during the initial start up of the inverter, with the input contactor closed and rectifier still shutdown, it is detected a wrong inverter voltage or it is not able to start up.

The system can retry the contactor test several times (see description of the screen 4.57 too).

- **Screen 4.30:** This alarm is displayed when the quantity of IGBT desaturations in the inverter, reaches its set limit.
- **Screen 4.31:** When the inverter output is overloaded, it is displayed this alarm. Depending on the level of this overload, the inverter will be shut down after some time according to the UPS overload curve.
- **Screen 4.32:** When a shutdown is enabled by an external signal, the inverter is shut down and it is displayed this message.
- **Screen 4.33:** When the inverter is running and the maintenance bypass switch is turned ON the inverter is shutdown immediately.
- **Screen 4.34:** This alarm appears when, in a parallel system, one UPS goes to battery mode. The inverter will shut down.

- **Screen 4.35:** This message indicates that one UPS of the parallel system is running over 160% of load.
- **Screen 4.36:** When an overtemperature is detected by the PFC or inverter temperature probes, after 1 minute the inverter is turned off automatically. If overtemperature condition remains after another 1 minute with the rectifier running, rectifier is also shutdown (alarm 4.71).
- **Screen 4.37:** This alarm is displayed when the rectifier is overloaded and depending on the level of this overload, the inverter is shut down after some time according to the rectifier overload curve. If this overload is still present with the inverter turned off, the rectifier will be blocked after 30" and the blocking alarm 4.72 will be displayed.
- **Screen 4.38:** This alarm is displayed when there is a (*) DSP Internal Error in the inverter module, shutting down the inverter immediately. There will be several retries before blocking the inverter.
- **Screen 4.39:** This alarm is displayed when an output short-circuit is detected, limiting the output RMS current up to the set value (150% of nominal current by default). The short-circuit is detected when the output voltage phase to neutral is lower than 16 % of nominal voltage. The system will retry twice to restart up.
- **Screen 4.40:** With the inverter running, if there's a wrong bypass phase rotation, the inverter will be shutdown.
- **Screen 4.41:** This alarm can be activated due to a connection of a load with high inrush current, or also, if it is detected a wrong transient voltage in the inverter (i.e., if there is a fault in an inverter transistor). In such case, the inverter will be shutdown for while and load will be transferred to bypass immediately. The equipment will retry to start up the inverter several times (see description of the screen 4.64 too).
- **Screen 4.42:** The way to start up the inverter is on voltage ramp mode (rms value from sinewave voltage starts at 0 Vrms till reaching its preset nominal value, i.e., 230 Vrms). If when doing the voltage ramp is detected any fault, the inverter will be shutdown for while, and it will retry to start it up several times (see description of the screen 4.58 too).
- **Screen 4.43:** In a parallel system, the inverters of the equipments of the system connected at the output can be shutdown, due to the management of system as a whole, therefore this alarm is displayed.
- **Screen 4.44:** This alarm means that the battery set has reached the level 10.5 V/bat when the equipment is on battery mode. This is the end of back up time, so the inverter of the UPS must be shutdown.
- **Screen 4.45:** This alarm is displayed when there is a (*) DSP Internal Error in the UPS module, shutting down the UPS immediately. There will be several retries before blocking the UPS.
- **Screen 4.45A:** Unlike the 4.36, in case that the inverter of the UPS is not started and the PFC-rectifier is charging the batteries, in case of internal over temperature detection, the operating of itself has to be shutdown. It will mean a total shutdown of the UPS (Rectifier and Inverter shutdown).
- **Screen 4.46:** This alarm is displayed when a combined shutdown of the PFC-rectifier and inverter has been done at the same time (due to different reasons).
- **Screen 4.47:** In parallel system, the equipments of the system connected at the output can be shutdown (complete shutdown of the rectifier and inverter), due to the management of system as a whole, therefore this alarm is displayed.
- **Screen 4.48:** The EPO (Emergency Power Off) button is pressed. The UPS and the static bypass are turned off and no AC voltage is present at the output.
- **Screen 4.49:** This alarm is displayed after 3 start up retries after detecting an output short-circuit. Then the UPS and the static bypass are turned off and no AC voltage present at the output.
- **Screen 4.50:** This alarm is displayed when there is a (*) DSP Internal Error in the UPS module, after stopping several times the UPS. The UPS blocks including the bypass, so no AC voltage present at the output.
- **Screen 4.51:** After several consecutive attempts, it is detected a wrong DC bus voltage (see screen 4.27), rectifier will be blocked permanently by displaying this alarm.
- **Screen 4.52:** This alarm is displayed when the UPS is blocked for any reason. Also this condition blocks the rectifier.
- **Screen 4.53:** After several times of shutting down the rectifier due to desaturations, this alarm will be displayed indicating rectifier blocked.
- **Screen 4.54:** If an error in the initial rectifier ramp is detected during the PFC start up, this alarm will be displayed blocking the rectifier.
- **Screen 4.55:** There is a command from the microprocessor to the rectifier DSP, with no response. The rectifier is blocked.
- **Screen 4.56:** After several times shutting down the rectifier because of (*) DSP Internal Error in the rectifier module, this alarm will be displayed indicating rectifier blocked.
- **Screen 4.57:** During the start up there is an input contactor test. If this test ends unsuccessfully the rectifier will be blocked.
- **Screen 4.58:** If Inverter voltage ramp is not done properly after several attempts, it will be blocked (see screen 4.42).
- **Screen 4.59:** This alarm appears when there is an offset voltage higher than 8V, in any phase of the inverter output (phase to neutral voltage). Next the inverter is blocked.
- **Screen 4.60:** This alarm is displayed when the UPS is blocked for any reason. Also this condition blocks the inverter.
- **Screen 4.61:** After several times of shutting down the inverter due to desaturations, this alarm will be displayed indicating inverter blocked.
- **Screen 4.62:** There is a command from the microprocessor to the inverter DSP, with no response. The inverter is blocked.
- **Screen 4.63:** After several times shutting down the inverter because of (*) DSP Internal Error in the inverter module, this alarm will be displayed and the inverter is blocked.
- **Screen 4.64:** After several attempts detecting "Inverter Fault/Overload" (see screen 4.41), the inverter is blocked permanently, and output is transferred to bypass.
- **Screen 4.65:** This alarm is displayed when the rectifier is blocked for any reason that also blocks the UPS.
- **Screen 4.66:** The alarm is displayed when the DSP doesn't response to the microprocessor during the initial procedure before starting up.
- **Screen 4.67:** There is a command from the microprocessor to the UPS module DSP, with no response. The UPS is blocked.

- **Screen 4.68:** This alarm is displayed when the inverter is blocked for any reason that also blocks the UPS.
- **Screen 4.69:** There is an internal error in the communication channel between microprocessor and DSP. This condition blocks the UPS.
- **Screen 4.70:** Unlike the cases 4.27, 4.51, if the DC Bus voltage is detected meanwhile the PFC-rectifier is not in operation (equipment discharging the batteries), the UPS has to be shut-down completely (inverter has to be shutdown too), so as a result the UPS will be blocked. This phenomena can be due to a failure of the UPS, or due to an "asymmetrical" consumption of a load connected at the output of the UPS (with average value different from 0V, so, with DC level). This type of loads are incompatible with the UPS.
- **Screen 4.71:** When an overtemperature is detected by the PFC or inverter temperature probes, first the inverter will be turned off after 1 minute time automatically (alarm 4.36). If 1 minute later the overtemperature is still present, the UPS will be completely blocked (rectifier also shut-down) and this alarm is displayed.
- **Screen 4.72:** When the rectifier is overloaded, depending on the level of this overload, the inverter will be shut down according to the rectifier overload curve (alarm 4.37). If this overload is still present with the inverter turned off, the UPS will be completely blocked (rectifier also shutdown) after 30", and this alarm will be displayed.
- **Screen 4.73:** When the quantity of desaturations of an inverter IGBT reaches its limit, the inverter is blocked. After two more retries this alarm UPS blocked is displayed.
- **Screen 4.74:** After several shutting down retries of the UPS because of (*) DSP Internal Error in the UPS module, this alarm will be displayed indicating UPS blocked.
 - **i** (*) A DSP Internal Error can happen because of the following reasons:
 - Watch Dog failure.
 - Wrong ADC measurements.
 - Communication errors between DSP and microprocessor.
- **Screen 4.75:** If there is a blocking condition for the inverter and another blocking condition for the PFC, this alarm will be displayed and the UPS will also be blocked.
- **Screen 4.76:** After the first error in the parallel system communication, when one of the equipments has already been chosen as a Fix Master in the system, a second error or break in the communications has been detected by the Slaves equipments, it will cause to block them permanently (Rectifier and Inverter are shutdown, no output voltage is supplied to the output of the system), by displaying this alarm.
- **Screen 4.77:** Input frequency auto-sensing failure. Equipment blocked.

This alarm will be displayed, when the input frequency selection in the installation menu is set to AUTOMATIC mode only and the input frequency is out of the acceptable range of $\pm 5\%$ respect to 50 or 60 Hz.

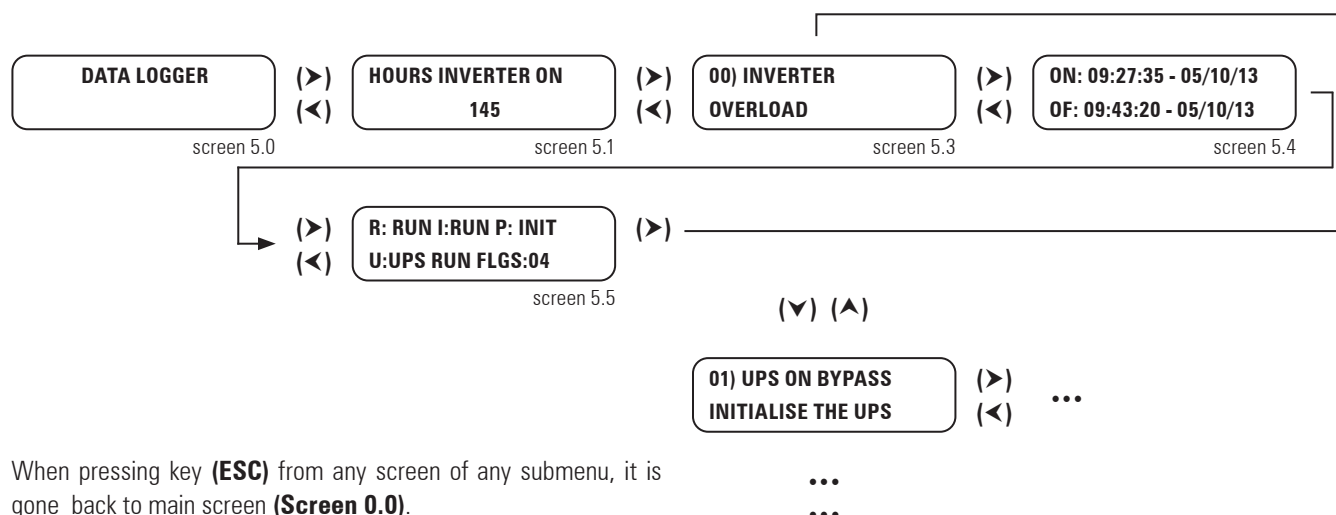

When pressing key **(ESC)** from any screen of any submenu, it is gone back to main screen **(Screen 0.0)**.

Fig. 53. Screen 5.0 «Data logger» and its submenus.

7.3.6. "DATA LOGGER" level (menu screen 5.0). See Fig 49.

- **Screen 5.1:** Indicates the inverter runtime from the first start up. This counter accumulates the total inverter running time from the beginning and it's not possible to reset it.
- **Screen 5.2:** This screen indicates that the data logger is empty. This happen only if authorised personnel resets this file.
- If the buffer is not empty, the following screen will inform about the data logger registers.

Using the (▼)-(▲) keys, you can move through the different registers of this data logger file. The data logger file can save up to 100 historic registers.

Using the (▶)-(◀) three different type screens of screen can be observed per register with the information described below.

- **Screen 5.3:** This screen shows the same information described above in the alarm screens except the three first characters where there is a register counter from 00) to 99).
- **Screen 5.4:** This screen is divided in two rows. In the first row shows the information about time and date of alarm activation:
 - hh: hour of alarm activation
 - mm: minutes of alarm activation
 - ss: seconds of alarm activation
 - dd: day of alarm activation
 - mm: month of alarm activation
 - aa: year of alarm activation

In the second row there is information about time and date of cleared alarm.

- hh: hour of cleared alarm
- mm: minutes of cleared alarm
- ss: seconds of cleared alarm
- dd: day of cleared alarm
- mm: month of cleared alarm
- aa: year of cleared alarm

- **Screen 5.5:** This is a screen for technical service only, in order to know the state of the different parts of the UPS at the moment the registered alarm was triggered.

7.3.7. "CONFIGURATION" level (menu screen 6.0). See Fig 51.

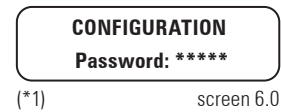

Fig. 55. Screen 6.0 «Configuration».

At this level an authorized password will be required to modify some advanced parameters.

7.3.8. Nominal values screens (menu screen 7.0). See Fig 50.

To modify the nominal values of the screens of this submenu, it is necessary to enter the «Password» on the previous screen 6.0, otherwise they only will be able to be visualized.

- **Screen 7.1:** This screen shows the nominal input rectifier and output voltages.
- **Screen 7.2:** This screen shows the upper and lower limit of input rectifier voltage.
- **Screen 7.3:** This screen shows the input bypass voltage and inverter output voltage. Equipments with separate bypass only.
- **Screen 7.4:** This screen shows the upper and lower limits of the bypass input voltage.
- **Screen 7.5:** This screen shows the nominal DC bus voltage and the nominal output current.
- **Screen 7.6:** This screen shows the nominal battery charging current.

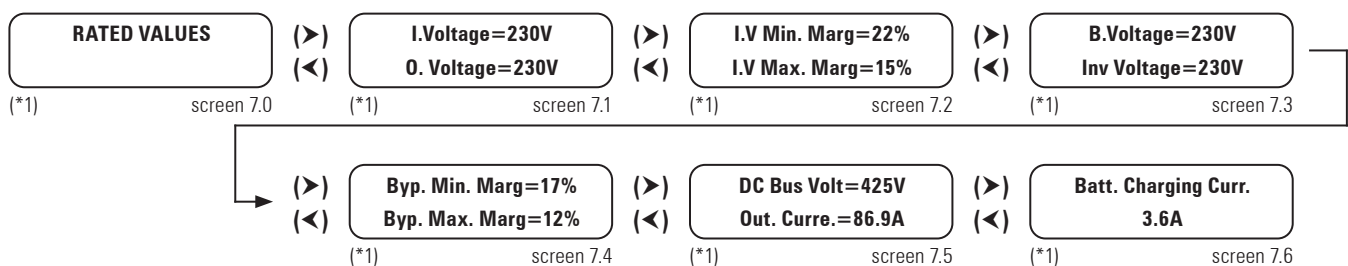

Fig. 54. Screen 7.0 «Nominal values» and its submenus.

8. MAINTENANCE, WARRANTY AND SERVICE.

8.1. MAINTENANCE BASIC GUIDE.

Batteries, fans and capacitors must be replaced at the end of their useful lifetime.



Inside the UPS there are dangerous voltages and metallic parts at very high temperatures, although the UPS is shut-down. The direct contact can cause electrocutions and burns. All the operating, less the battery fuse replacing, must be done by authorised technical staff.



Some internal parts of the UPS (terminals, EMC filters and measurement circuits) are still under voltage during the maintenance bypass operating. To cancel all the voltages, the circuit breakers of mains and bypass of the panel board that feeds the UPS and the fuse holders of the battery rack have to be turned «OFF» / «0».

8.1.1. Battery fuses.

Turning on the battery switch and/or fuse holder «ON» or «I» position, **and only after** displaying the alarm message «BATT. SWITCH OPEN, SWITCH IT ON» in the LCD panel.



The battery fuses can only be replaced by ultrafast fuse models type aR 660V, of the same size and current used in the equipment and/or battery module.

8.1.2. Batteries.

The useful lifetime of the batteries depends on the ambient temperature and other factors like the quantity of charging and discharging cycles and the deep discharges done.

Its design lifetime is between 3 and 5 years if the ambient temperature is between 10 and 20 °C. Under request, other typology and/or design lifetime batteries can be supplied.

To get more information about their status, activate the battery test.



Risk of fire and/or explosion exists if a wrong quantity or type of batteries is used. Do not dispose the batteries to the fire: they can explode. Do not open and mutilate the batteries: the dumped electrolyte is dangerous for the skin and eyes. It can be toxic.

8.1.3. Fans.

The useful lifetime of the used fans to cool the power circuits depends on the use and environment conditions. It is recommended their preventive replacement by authorised technical staff.

8.1.4. Capacitors.

The useful lifetime of the DC bus capacitors and those ones used in the input and output filtering depends on the use and the environment conditions. It is recommended their preventive replacement by authorised technical staff.

8.2. WARRANTY CONDITIONS.

8.2.1. Warranty terms.

The warranty conditions for the acquired product can be found in our website and in that you will be able to register it. It is recommended to do it as soon as possible in order to include it in the Technical Service & Support (**T.S.S.**) database. Among other advantages, it will be easier to make any regulatory process to allow the (**T.S.S.**) action in case of any hypothetical fault.

8.2.2. Out of scope of supply.

Our company is not forced by the warranty if it appreciates that the defect in the product doesn't exist or it was caused by a wrong use, negligence, installation and/or inadequate testing, tentative of non-authorised repairing or modification, or any other cause beyond the foreseen use, or by accident, fire, lightnings or other dangers. Neither it will cover, in any case, compensations for damages or injuries.

8.3. TECHNICAL SERVICE NETWORK.

Coverage, both national and international, from our Technical Service & Support (**T.S.S.**), can be found in our Website.

9. ANNEXES.

9.1. PARTICULAR SPECIFICATIONS, EQUIPMENTS (LV).

Nominal power (kVA)		5	7.5	10	15	20	30	40	50	60	80	100
Nominal power (kW)		Depending on the input/output setting and power supply voltage (See chart 9)										
INPUT												
Nominal voltage		Single phase 115V, 120V, 127V or 133V							-			
Input voltage range		Three phase 3x200V, 3x208V, 3x220V or 3x230V (4 wires: 3 phases+ N) +15% / -20% (configurable)										
Frequency		50 / 60 Hz ± 5 Hz ((selectable among 0.5 - 1 - 2 or 5 Hz)										
Total input current distortion (depending on the quality of input mains)		100 % load: THD-i < 1.5 % 50 % load: THD-i < 2.5 % 10 % load: THD-i < 6.0 %			100 % load: THD-i < 1.0 % 50 % load: THD-i < 2.0 % 10 % load: THD-i < 5.0 %			100 % load: THD-i < 1.5 % 50 % load: THD-i < 2.0 % 10 % load: THD-i < 6.0 %				
Current limit		High overload: PFC limit (discharging batteries)										
Power factor		1.0 from 10% load										
Rated conditional short-circuit current -I _{cc} - (kA)	III/III (with common input)	6					10			10		
	III/III-B (rectifier input)	6					10			10		
	III/III-B (bypass input)	6					10			10		
	(L) I/I (with common input)	6		10		-		-		-		-
	(L) I/I-B (rectifier input)	6		10		-		-		-		-
	(L) I/I-B (bypass input)	6		10		-		-		-		-
	(M) I/III-B (rectifier input)	6		10		-		-		-		-
	(M) I/III-B (bypass input)	6		10		-		-		-		-
	(N) III/I-B (rectifier input)	6		10		-		-		-		-
(N) III/I-B (bypass input)	6		10		-		-		-		-	
INVERTER												
Output nominal voltage		Single phase 115V, 120V, 127V or 133V							-			
Output power factor		0.9 for three phase/three phase setting and 0.8 for L, M, N or AUTO settings										
Accuracy		Static: ± 1 %. Dynamic: ± 2 % (step loads 100-0-100 %)										
Output frequency		50 / 60 Hz synchronised ± 5 Hz. Free running ± 0.05 %										
Maximum slew rate		From 1 to 10 Hz/s (programmable)										
Output wave shape		Sinewave										
Total output voltage harmonic distortion		Linear load: THD-v < 0.5 %. Ref. non-linear load (EN-62040-3): THD-v < 1.5 %										
Phase shifting		120 $\pm 1^\circ$ (balanced load). 120 $\pm 2^\circ$ (unbalanced load of 100 %)										
Dynamic response time		10 ms. till 98 % of the static value										
⁽⁷⁾ Permissible overload		125 % for 10 min., >125.. 135 % for 5 min., >135.. 150 % for 1 min., > 150 % for 20 ms.										
Permissible crest factor		3.4 to 1		3.2 to 1		2.8 to 1		3.2 to 1		3 to 1		
Permissible power factor		0.7 leading to 0.7 lagging										
Unbalanced output voltage (100 % unbalanced load)		< 1 %										
Current limit		High overload, short-circuit: RMS voltage limit. High current crest factor: Peak voltage limit										
Efficiency on battery mode (100% linear load) (%)		94.3	95.3	95.6	95.8	96.4		96.5	96.4	96.8	96.9	
STATIC BYPASS												
Type		Solid state(SCR)										
Bypass line		Common. Separate as an option (B)										
Nominal voltage		Single phase 115V, 120V, 127V or 133V							-			
Voltage range		Three phase 3x200V, 3x208V, 3x220V or 3x230V (4 wires: 3 phases + N) Preset +12 % (adjustable between +20... +5%) / -15% (adjustable between -25... -5%)										
Voltage hysteresis		± 2 % as regards the bypass voltage range. In a standard equipment is +10 / -13%										
Frequency		50 / 60 Hz										
Frequency range		± 5 Hz (selectable between 0.5 - 1.0 - 2 and 5.0 Hz)										
Frequency hysteresis		1 Hz as regards the frequency range (selectable among 0.2 - 0.5 - 1.0 and 2.0 Hz)										
Activation criteria		Controlled by microprocessor										
Transference time		Nil, less in Smart ECO Mode < 4 ms										
Permissible overload		400 % for 10 s										
Transference to bypass		Immediately, for overloads over 150 %										
Re-transference		Automatic after alarm cancelling										
Efficiency on Smart ECO Mode (%)		95.0	95.5	96.0	97.4	97.8	98.0	98.4	98.0			
MANUAL BYPASS (MAINTENANCE)												
Type		Make before break										

Nominal power (kVA)	5	7.5	10	15	20	30	40	50	60	80	100	
Nominal power (kW)	Depending on the input/output setting and power supply voltage (See chart 9)											
Nominal voltage	Single phase 115V, 120V, 127V or 133V								-			
Frequency	Three phase 3x200V, 3x208V, 3x220V or 3x230V (4 wires: 3 phases + N)											
SHORT CIRCUIT CURRENT (kA)	6					10		25		100		
GENERAL												
Total efficiency (100% linear load) (%)	89	89.5	90	91	91.5	92	93	92.5	92	93.0		
BATTERIES												
Quantity	38		36				40		38		40	
⁽⁸⁾ Type	Pb-Ca											
Floating voltage per battery	13.65 V at 20°C											
Compensation of the battery floating voltage	Adjustable (preset to -18 mV/°C)											
Capacity (Ah)	7		12		18		26		40		65	
Standard charging current (Cx0,2) (A)	1.4		2.4		3.6		5.2		8		13	
Battery terminal torque	According to battery manufacturer											
Fitted in the same UPS cabinet	YES						NO					
DIMENSIONS AND WEIGHTS FOR UPS CONFIGURATIONS WITH STANDARD BACK UP TIME												
Quantity of cabinets	1 (UPS + batteries)						1 (UPS) / 1 (batteries)					
Maximum dimensions(mm) (Depth x Width x Height)	CUBE3+ / CUBE3+ B1		775x450x1100				880x590x1325		850x900x1905			
	CUBE3+ B / CUBE3+ B B1						880x870x1325		850x1225x1905			
	Batteries		-				1050x650x1325		850x1305x1905			
Casters without brake. Equipment / batteries	YES / -					YES / YES		YES / NO		NO / NO		
Cabinet weight (kg)	CUBE3+ B1		97	99	102	147	172	-	-	-	-	-
	CUBE3+ B B1		99	101	105	150	175	-	-	-	-	-
	CUBE3+		207	209	235	319	417	185	265	290	290	540
	CUBE3+ B		209	211	237	322	420	190	275	310	310	570
	External batteries		-	-	-	-	-	424	501	594		1096

Table 8. Technical specifications for equipments with (LV) voltages.

9.2. TECHNICAL SPECIFICATIONS, EQUIPMENTS (HV).

Nominal power (kVA)	7.5	10	15	20	30	40	50	60	80	100	120	160	200
Nominal power (kW)	Depending on the input/output setting and power supply voltage (See chart 9)												
INPUT													
Nominal voltage	Single phase 220V, 230V or 240V								-				
Input voltage range	Three phase 3x380V, 3x400V or 3x415V (4 wires: 3 phases + N)												
Frequency	+15% / -20% (configurable)												
Frequency	50 / 60 Hz ± 5 Hz (selectable from 0.5, 1, 2 or 5 Hz)												
Total input current distortion (depending on the quality of input mains)	100 % load: THD-i < 1.5 % 50 % load: THD-i < 2.5 % 10 % load: THD-i < 6.0 %				100 % load: THD-i < 1.0 % 50 % load: THD-i < 2.0 % 10 % load: THD-i < 5.0 %				100 % load: THD-i < 1.5 % 50 % load: THD-i < 2.0 % 10 % load: THD-i < 6.0 %				
Current limit	High overload: PFC limit (discharging batteries)												
Power factor	1.0 from 10% load												
Rated conditional short-circuit current -Icc- (kA)	III/III (with common input)		6				10				10		
	III/III-B (rectifier input)		6				10				10		
	III/III-B (bypass input)		6				10				10		
	(L) I/I (with common input)		6				10				-		
	(L) I/I-B (rectifier input)		6				10				-		
	(L) I/I-B (bypass input)		6				10				-		
	(M) I/III-B (rectifier input)		6				10				-		
	(M) I/III-B (bypass input)		6				10				-		
	(N) III/I-B (rectifier input)		6				10				-		
(N) III/I-B (bypass input)		6				10				-			
INVERTER													
Output nominal voltage	Single phase 220V, 230V or 240V								-				
Output power factor	Three phase 3x380V, 3x400V or 3x415V (4 wires: 3 phases + N)												
Accuracy	0.9 for three phase/three phase setting and 0.8 for L, M, N or AUTO settings												
Output frequency	Static: ±1 %. Dynamic: ±2 % (step loads 100-0-100 %)												
Maximum slew rate	50 / 60 Hz synchronised ±5 Hz. Free running ±0.05 %												
Output wave shape	From 1 to 10 Hz/s (programmable)												
Output wave shape	Sinewave												

Nominal power (kVA)	7.5	10	15	20	30	40	50	60	80	100	120	160	200	
Nominal power (kW)	Depending on the input/output setting and power supply voltage (See chart 9)													
Total output voltage harmonic distortion	Linear load: THD-v < 0.5 %. Ref. non-linear load (EN-62040-3): THD-v < 1.5 %													
Phase shifting	120 ±1° (balanced load). 120 ±2° (unbalanced load of 100 %)													
Dynamic response time	10 ms. at 98 % of the static value													
⁽⁷⁾ Permissible overload	125 % for 10 min., >125.. 135 % for 5 min., >135.. 150 % for 1 min., > 150 % for 20 ms.													
Permissible crest factor	3.4 to 1			3.2 to 1			2.8 to 1		3.2 to 1		3 to 1			
Permissible power factor	0.7 leading to 0.7 lagging													
Unbalanced output voltage (100 % unbalanced load)	< 1 %													
Current limit	High overload, short-circuit: RMS voltage limit. High current crest factor: Peak voltage limit													
Efficiency on battery mode (100% linear load) (%)	94.3	94.8	95.3	95.6	95.9	96.4	96.3	96.4	96.4	96.5	96.4	96.8	96.9	
STATIC BYPASS														
Type	Solid state													
Bypass line	Common. Separate as an option (B)													
Nominal voltage	Single phase 220V, 230V or 240V								-					
	Three phase 3x380V, 3x400V or 3x415V (4 wires: 3 phases + N)													
Voltage range	Preset +12 % (adjustable between +20... +5%) / -15% (adjustable between -25... -5%)													
Voltage hysteresis	±2 % as regards to bypass voltage range. In a standard equipment is of +10 /-13%													
Frequency	50 / 60 Hz													
Frequency range	±5 Hz (selectable among 0.5 - 1.0 - 2 and 5.0 Hz)													
Frequency hysteresis	1 Hz as regards the frequency range (selectable among 0.2 - 0.5 - 1.0 and 2.0 Hz)													
Activation criteria	Controlled by microprocessor													
Transference time	Nil, less in Smart ECO Mode < 4 ms													
Permissible overload	400 % for 10 s													
Transference to bypass	Immediate, for overloads higher than 150 %													
Re-transference	Automatic after alarm cancelling													
Efficiency on Smart ECO Mode (%)	95	95.5	96	97.4	97.8	98	98.4	98.4	98	98	98	98	98	
MANUAL BYPASS (MAINTENANCE)														
Type	Make before break													
Nominal voltage	Single phase 220V, 230V or 240V								-					
	Three phase 3x380V, 3x400V or 3x415V (4 wires: 3 phases + N)													
Frequency	50 / 60 Hz													
SHORT CIRCUIT CURRENT (kA)	6			10			25		100					
GENERAL														
Total efficiency (100% linear load) (%)	91.0	92	92.5	93.5	94.0	95.0	94.5	94.0	95.0	94.5	94.0	95.0	95.0	
BATTERIES														
Quantity	31 + 31													
⁽⁸⁾ Type	Pb-Ca													
Floating voltage per battery	13.65 V at 20°C													
Compensation of the battery floating voltage	Adjustable (Preset to -18 mV/°C)													
Capacity (Ah)	4.5	7	9	12	12	2x12	40	65	80	80	13	16	16	
Standard charging current (Cx0,2) (A)	0.9	1.4	1.8	2.4	2.4	4.8	8.0	13	16	16	13	16	16	
Battery terminal torque	According to battery manufacturer													
Fitted in the same UPS cabinet	YES						NO							
DIMENSIONS AND WEIGHTS FOR UPS CONFIGURATIONS WITH STANDARD BACK UP TIME														
Quantity of cabinets	1 (UPS + batteries)						1 (UPS) / 1 (batteries)							
Maximum dimensions(mm) (Depth x Width x Height)	CUBE3+ / CUBE3+ B1	775x450x1100						880x590x1325			850x900x1905			
	CUBE3+ B / CUBE3+ B B1							880x870x1325			850x1225x1905			
	Batteries							1050x650x1325			850x1305x1905			
Casters without brake. Equipment / batteries	YES / -						YES / YES		YES / NO			NO / NO		
Cabinet weight (kg)	CUBE3+ B1	97	97	99	102	147	172	-	-	-	-	-	-	
	CUBE3+ B B1	99	99	101	105	150	175	-	-	-	-	-	-	
	CUBE3+	207	207	209	235	319	417	185	185	265	290	290	540	550
	CUBE3+ B	209	209	211	237	322	420	190	190	275	310	310	570	580
External batteries	-	-	-	-	-	-	321	551	1020	1020	1020	1655	1690	

Table 9. Technical specifications of equipments with (HV) voltage.



Additional informations referred to charts 8 and 9:

- UPSs up to 20 kVA (LV) / 40 kVA (HV) with standard back up time are supplied in only one cabinet, batteries included. For extended back up times and/or higher power rates, the UPS and batteries are supplied in separate cabinets.

- (7) Permissible overload per phase or total overload at P.F. 0.8.
- (8) Batteries fitted in as standard are Pb-Ca type.
As an option Ni-Cd batteries can be supplied, fitted in a separate cabinet or rack.

It is also possible to have a common battery set of Pb-Ca or Ni-Cd type fitted in a cabinet or rack, for two equipments in parallel.

- CUBE3+ B** Equipment with separate bypass line.
- CUBE3+ B B1** Equipment with separate bypass line, neither batteries nor accessories (bolts, cables,...).
- The input, output and bypass currents (the last one is available in B equipments only), as well as the short-circuit current (Icc) in kA are printed in the nameplate of each model, so they are not stated in this document.

Model	Input-output configuration	Voltage (V)	Power (kVA / kW)	
			Config. III/III	Config. L/M/N/AUTO
SLC-5-CUBE3+	No ref. : III / III L : I / I M : I / III N : III / I	«LV» 3x200... 3x230 V (115... 133 V in single phase)	5 / 4.5	5 / 4
SLC-7,5-CUBE3+			7.5 / 6.75	7.5 / 6
SLC-10-CUBE3+			10 / 9	10 / 8
SLC-15-CUBE3+			15 / 13.5	15 / 12
SLC-20-CUBE3+			20 / 18	20 / 16
SLC-30-CUBE3+			30 / 27	30 / 24
SLC-40-CUBE3+			40 / 36	40 / 32
SLC-50-CUBE3+			50 / 45	50 / 40
SLC-60-CUBE3+			60 / 54	60 / 48
SLC-80-CUBE3+			80 / 72	80 / 64
SLC-100-CUBE3+	100 / 90	100 / 80		
SLC-7,5-CUBE3+	No ref. : III / III L : I / I M : I / III N : III / I	«HV» 3x380... 3x415 V (220... 240 V in single phase)	7.5 / 6.75	7.5 / 6
SLC-10-CUBE3+			10 / 9	10 / 8
SLC-15-CUBE3+			15 / 13.5	15 / 12
SLC-20-CUBE3+			20 / 18	20 / 16
SLC-30-CUBE3+			30 / 27	30 / 24
SLC-40-CUBE3+			40 / 36	40 / 32
SLC-50-CUBE3+			50 / 45	50 / 40
SLC-60-CUBE3+			60 / 54	60 / 48
SLC-80-CUBE3+			80 / 72	80 / 64
SLC-100-CUBE3+			100 / 90	100 / 80
SLC-120-CUBE3+	Available in III / III configuration only		120 / 108	120 / 96
SLC-160-CUBE3+			160 / 144	160 / 128
SLC-200-CUBE3+			200 / 180	200 / 160

Table 10. Powers according to model, configuration and operating voltage.

9.3. GLOSSARY.

- **AC.-** It is nominated as alternating current to the electrical current in which the magnitude and direction varies in a cyclic way. The most common wave shape of the alternating current is sinewave, because the energy transmission is better. Nevertheless, some applications could need other period wave shapes, like triangular or square.
- **Bypass.-** Manual or automatic, it is the physical junction between the input and the output electric device.
- **DC.-** The direct current is the continuous electron flow through a cable between two points with different potential. Unlike the alter-

nating current, in direct current the electrical loads always flow in the same direction from the highest potential point to the lowest one. Although, usually the direct current is identified with the constant current (for example the one supplied by the battery), it is continuous any current that always maintain the polarity.

- **DSP.-** It is the acronym of Digital Signal Processor. A DSP is a system based on a processor or microprocessor that has instructions in it, a hardware and an optimized software to develop applications where numerical operations are needed with very fast speed. Due to this, it is very useful to process analogical signals in real time: in a system that runs in this way (real time) samples are received, usually coming from an analogical/digital converter(ADC).
- **Power factor.-** It is defined as power factor, p.f., of an alternating current circuit, as the ratio between the active power, P, and the apparent power, S, or as the cosines of the angle that make the current and voltage vectors, designating as φ , being j the value of that angle.
- **GND.-** The term ground, as its name states, refers to the potential of the earth surface.
- **IGBT.-** The Insulated Gate Bipolar Transistor is a semiconductor device that is used as a controlled switch in power electronic circuits. This device has the feature of the gate signal of the effect field transistors with the capacity of high current and low voltage saturation of the bipolar transistor, combining an isolated FET gate for the input and a bipolar transistor as switch in a single device. The triggering circuit of the IGBT is as the MOSFET one, while the driving features are like the BJT.
- **Interface.-** In electronic, telecommunications and hardware, an interface (electronic) is the port (physical circuit) through which are sent or received signals from a system or subsystems toward others.
- **kVA.-** The voltampere is the unit of the apparent power in electrical current. In direct current is almost equal to the real power but in alternating current can defer depending on the power factor.
- **LCD.-** LCD acronym of Liquid Crystal Display, device invented by Jack Janning, who was employee of NCR. It is an electric system of data presentation based on 2 transparent conductor layers and in the middle a special crystal liquid that have the capacity to orientate the light when trespassing.
- **LED.-** LED acronym of Light Emitting Diode, is a semiconductor device (diode) that emits light almost monochrome with a very narrow spectrum, it means, when it is direct polarized and it is crossed by an electric current. The colour, (wave longitude), depends on the semiconductor material used in its construction, being able to vary from the ultraviolet one, going through the visible spectrum light, to the infrared, receiving these last ones the denomination of IRED (Infra Red Emitting Diode).
- **Circuit breaker.-** A circuit breaker or switch, is a device ready to break the electrical current of a circuit when it overcomes the maximum set values.
- **On-Line mode.-** Regarding to an equipment, it is on line when it is connected to the system, and it is in operation, and usually has its power supply turned on.
- **Inverter.-** An inverter, is a circuit used to convert direct current into alternating current. The function of an inverter is to change an input voltage of direct current into a symmetrical output voltage of alternating current, with the required magnitude and frequency by the user or the designer.

- **Rectifier.-** In electronic, a rectifier is the element or circuit that allows to convert the alternating current into direct current. This is done by rectifier diodes, which can be solid state semiconductors, vacuum or gassy valves as the mercury vapour. Depending on the features of the alternating current power supply used, it is classified as single phase, when they are fed by a single phase electrical mains, or three phase when they are fed by the three phases. Depending on the rectification type, they can be half wave, when only one of the current semi-cycles is used, or full wave, where both semi-cycles are used.
- **Relay.-** The relay(in French relais, relief) is an electromechanical device that works as a switch controlled by an electric circuit where, through an electromagnet, a set of contacts are moved and it allows to open or to close other independent electric circuits.
- **Electrical enclosure.-** Part of the equipment destined to limit the access to those parts that could have HAZARDOUS VOLTAGES or DANGEROUS ENERGY LEVELS or to be in TNV circuits.
- **Accessibility.-**

OPERATOR ACCESS AREA.

Part of the equipment that, in normal operating conditions, applies one of the following conditions:

- There is access to this part without any tool.
- The access mean is allowed to the operator deliberately.
- The operator is trained to have access regardless of a tool is needed or not.

The "access" and "accessible" terms, unless otherwise noted, are applied to OPERATOR ACCESS AREA as it has been stated previously.

MAINTENANCE ACCESS AREA.

Part of the equipment, different to the OPERATOR ACCESS AREA, which the MAINTENANCE STAFF needs access, even with the equipment turned on.

RESTRICTED ACCESS AREA.

Location for the equipment that the following conditions are met:

- MAINTENANCE STAFF or END-USERS properly trained in the reasons of the restrictions applied to both over the location and over any caution that has to be kept in mind, can have access only; and
- The access is by means of a tool or a lock with key or other safety means, and it is controlled by the responsible authority of the location.

MAINTENANCE STAFF.

- Person with the duly technical training and the needed experience to be aware of both the danger that he can be exposed to when carrying a determined task out and the means to minimize the risks to other persons and himself.

END-USER OR OPERATOR.

- Any person different from the MAINTENANCE STAFF. It is used the END-USER or OPERATOR term.

MAINTENANCE STAFF.

- Person with the duly technical training and the needed experience to be aware of both the danger that he can be exposed to when carrying a determined task out and the means to minimize the risks to other persons and himself.

SALICRU

Avda. de la Serra 100

08460 Palautordera

BARCELONA

Tel. +34 93 848 24 00

services@salicru.com

SALICRU.COM



The Technical Service & Support (T.S.S.) network, Commercial network and warranty information are available in website:

www.salicru.com

Product Range

Uninterruptible Power Supplies (UPS)

Lighting Flow Dimmer-Stabilisers

DC Power Systems

Static Inverters

Photovoltaic Inverters

Voltage stabilisers



@salicru_SA



www.linkedin.com/company/salicru

